



Federal Office
for Information Security

BSI Technical Guideline TR-03121-3

Biometrics for Public Sector Applications

Part 3: Application Profiles, Function Modules and Processes

Volume 4: Alien Register Enrolment

Version 5.0



Federal Office for Information Security

P.O. Box 20 03 63

53133 Bonn, Germany

E-mail: TRBiometrics@bsi.bund.de

Web: <https://bsi.bund.de>

© Federal Office for Information Security 2019

1.	Introduction	1
1.1.	Business Process Modelling Notation (BPMN)	1
2.	Volume Documents for Asylum Seekers	2
3.	Application Profiles	3
3.1.	Application Profile Arrival Attestation Document	3
3.1.1.	System Overview	3
3.1.2.	Mandatory Process	4
3.1.3.	Relevant Standards and Conditions	4
3.1.4.	Mandatory Function Modules	5
3.1.5.	Mandatory Partial Application Processes	6
4.	Partial Application Processes	7
4.1.	General Process Requirements	7
4.1.1.	Requirements	7
4.1.2.	Recommendations	7
4.2.	PAP ACQ-FI-SV-2: Supervised Facial Image Acquisition with CIR Lookup	7
4.3.	PAP ACQ-FP442-SV-2: Supervised Acquisition 4-4-2 for Enrolment without Fall-back Single Finger Acquisition	8
4.3.1.	PAP Task ACQ-FPS-SV-2: Capture Slap Supervised without Fall-back Single Finger Acquisition	9
4.4.	PAP ACQ-FP4141-SV-2: Supervised Acquisition 4-1-4-1 for Enrolment without Fall-back Single Finger Acquisition	10
4.4.1.	PAP Task ACQ-FPS-SV-2: Capture Slap Supervised without Fall-back Single Finger Acquisition	11
4.5.	PAP ACQ-FP10R-SV-1: Ten Finger Rolled Supervised Acquisition for Enrolment	12
4.5.1.	PAP Task ACQ-FPR-1: Capture Rolled Finger	13
5.	Function Modules	15
5.1.	FM Category Acquisition Hardware	15
5.1.1.	FM AH-FI-DC	15
5.1.2.	FM AH-FP-OPT	15
5.2.	FM Category Acquisition Software	18
5.2.1.	FM AS-FI-DC	18
5.2.2.	FM AS-FP-ROLL	18
5.2.3.	FM AS-FP-MF	19
5.3.	FM Category Biometric Image Processing	20
5.3.1.	FM BIP-FI-DC-HQ	20
5.3.2.	FM BIP-FP-APP	21
5.4.	FM Category Quality Assessment	21
5.4.1.	FM QA-FI-PG	21

5.4.2.	FM QA-FI-SB	22
5.4.3.	FM QA-FP-APP	25
5.5.	FM Category Presentation Attack Detection	28
5.5.1.	FM PAD-FP-APP1	28
5.6.	FM Category Compression	30
5.6.1.	FM COM-FI-JPG	30
5.6.2.	FM COM-FP-WSQE	30
5.7.	FM Category Operation	31
5.7.1.	FM O-FI-ALL	31
5.7.2.	FM O-FI-DC	31
5.7.3.	FM O-FP-ALL	31
5.8.	FM Category User Interface	32
5.8.1.	FM UI-FI-OP	32
5.8.2.	FM UI-FI-BSJ	32
5.8.3.	FM UI-FP-OP	33
5.8.4.	FM UI-FP-BSJ	33
5.9.	FM Category Reference Storage	34
5.9.1.	FM REF-FP-AAD	34
5.9.2.	FM REF-FI-AAD	34
5.10.	FM Category Biometric Comparison	34
5.10.1.	FM CMP-FP-CC	34
5.11.	FM Category Logging	35
5.11.1.	FM LOG-ALL-GENERIC	35
5.11.2.	FM LOG-ALL-AAD	36
5.11.3.	FM LOG-FP-GENERIC	37
5.11.4.	FM LOG-FI-GENERIC	38
5.12.	FM Category Coding	39
5.12.1.	FM COD-ALL-AAD	39
5.12.2.	FM COD-FP-GSAT3	39
5.12.3.	FM COD-FI-GSAT3	40
5.13.	FM Category Evaluation	40
5.13.1.	FM EVA-ALL-GENERIC	40
5.13.2.	FM EVA-ALL-PROCESS	62
5.13.3.	FM EVA-ALL-AAD	68
5.13.4.	FM EVA-FP-GENERIC	69
5.13.5.	FM EVA-FP-CENTRAL	83
5.13.6.	FM EVA-FP-PAD	85
5.13.7.	FM EVA-FP-AAD	87

5.13.8. FM EVA-FI-GENERIC 88

5.13.9. FM EVA-FI-CENTRAL 91

5.13.10. FM EVA-FI-AAD 93

List of Abbreviations 94

Bibliography 95

List of Figures

1.1.	BPMN-icons Used for the Process Modelling	1
3.1.	System Architecture Overview	3
3.2.	Process Overview	4
4.1.	Partial Application Process "Supervised Facial Image Acquisition Process with CIR Lookup"	8
4.2.	Partial Application Process "Supervised Acquisition 4-4-2 for Enrolment without Fall-back Single Finger Acquisition"	9
4.3.	Partial Application Process Task "Capture Slap Supervised without Fall-back Single Finger Acquisition"	10
4.4.	Partial Application Process "Supervised Acquisition 4-1-4-1 for Enrolment without Fall-back Single Finger Acquisition"	11
4.5.	Partial Application Process Task "Capture Slap Supervised without Fall-back Single Finger Acquisition"	12
4.6.	Partial Application Process "Supervised Acquisition Process Ten Rolled Fingerprints for Enrolment"	13
4.7.	Partial Application Process Task "Capture Rolled Finger"	14
5.1.	Example Heat Map	44
5.2.	Example Box Plot	45
5.3.	Example Scatter Plot	46
5.4.	Example Line Plot	47
5.5.	Example Histogram Plot	48
5.6.	Example Histogram with Empirical Cumulative Distribution Function	49
5.7.	Example Bar Plot	50
5.8.	Example Horizontal Stacked Bar Plot	51
5.9.	Example Vertical Stacked Bar Plot	51
5.10.	Example Grouped Bar Plot	52
5.11.	Example Table with Alternation Background Colour	53

List of Tables

3.1. Required Function Modules Application Profile Arrival Attestation Document	5
3.2. Required Partial Application Processes Application Profile Arrival Attention Document	6
5.1. Minimum and Maximum Modulation	16
5.2. Image Acquisition Settings Levels	19
5.3. Requirements for the Size of Facial Images	20
5.4. Requirements for the Size of Facial Images in GSAT Transactions	20
5.5. Mapping of Relevant Quality Criteria	23
5.6. Application Specific Thresholds for Facial Images	24
5.7. Thresholds for Plain Fingerprints for Enrolment Purposes	27
5.8. Thresholds for Plain Control /Identification Fingerprints	27
5.9. Thresholds for Rolled Fingerprints	28
5.10. Usability Metrics Fingerprint PAD	29
5.11. Requirements to Compression Using JPEG Format	30
5.12. Recommended Colour Palettes	41
5.13. Heat Map Colours	43
5.14. Heat Map Absolute Frequency Lookup Table Definition	53
5.15. Example Heat Map Lookup Table Absolute Frequencies	54
5.16. Heat Map Absolute Frequency Lookup Table Definition	54
5.17. Example Heat Map Lookup Table for Relative Frequencies	54
5.18. Histogram Lookup Table Definition	55
5.19. Example Histogram Lookup Table	55
5.20. Absolute Frequency Stacked Bar Plot Lookup Table Definition	56
5.21. Example Absolute Frequency Stacked Bar Plot Lookup Table	56
5.22. Relative Frequency Stacked Bar Plot Lookup Table Definition	56
5.23. Example Relative Frequency Stacked Bar Plot Lookup Table	57
5.24. Box Plot Lookup Table Definition	57
5.25. Example Box Plot Lookup Table	57
5.26. Top and Bottom Table Definition	58
5.27. Example Top Table	58
5.28. Example Bottom Table	58
5.29. Component Usage Table Definition	59
5.30. Example Component Usabe Table	59
5.31. Threshold Configuration Table Definition	59
5.32. Example Threshold Configuration Table	60
5.33. Absolute Frequency Line Plot Lookup Table Definition	61
5.34. Example Absolute Frequency Line Plot Lookup Table	61
5.35. Relative Frequency Line Plot Lookup Table Definition	61
5.36. Example Relative Frequency Line Plot Lookup Table	62
5.37. Evaluation Number of Acquisition Processes	62
5.38. Line Plot Number of Acquisition Processes	62

5.39. Evaluation Identification Duration	63
5.40. Histogram Finger Identification Process Duration	63
5.41. Top and Bottom Locations by Finger Identification Process Duration	63
5.42. Evaluation Identification Process Result	64
5.43. Stacked Bar Plot Global Identification Process Result	64
5.44. Top and Bottom Locations by Identification Process Result	65
5.45. Histogram Finger Identification Candidate's Achieved FMR	65
5.46. Evaluation Single Verification Process Result	66
5.47. Stacked Bar Plot Global Single Verification Process Result	66
5.48. Histogram Single Verification Achieved FMR	66
5.49. Evaluation Single Verification Process Duration	67
5.50. Histogram Single Verification Process Duration	67
5.51. Top and Bottom Locations by Single Verification Process Duration	68
5.52. Required Evaluations EVA-ALL-AAD	68
5.53. Evaluation Finger Capture Component	69
5.54. Heat Map Finger Acquisitions by Software	69
5.55. Heat Map Finger Acquisitions by Hardware	69
5.56. Evaluation Number of Finger Captures	70
5.57. Stacked Bar Plot Number of Finger Captures	70
5.58. Top and Bottom Locations by Finger Capture Count Mean	71
5.59. Evaluation Number of Finger Captures by Finger	71
5.60. Stacked Bar Plot Number of Finger Captures by Finger	71
5.61. Evaluation Rejection Reason of Finger Capture Attempts by Finger	72
5.62. Stacked Bar Rejection Reasons of Finger Capture Attempts by Finger	72
5.63. Evaluation Success Rate of Finger Capture Attempts	73
5.64. Stacked Bar Success Rate of Finger Capture Attempts by Finger	73
5.65. Number of Finger Captures per Applicant	73
5.66. Histogram Number of Finger Capture Attempts per Applicant	73
5.67. Evaluation NFIQ 2.0 Fingerprint Image Quality	74
5.68. Stacked Bar Plot Relative Finger Quality Assessment Errors	74
5.69. Histogram NFIQ 2.0 Fingerprint Image Quality	75
5.70. Box Plot NFIQ 2.0 Fingerprint Image Quality Finger Comparison	75
5.71. Top and Bottom Locations by NFIQ 2.0 Result	76
5.72. Evaluation Finger Capture Duration	76
5.73. Histogram Finger Capture Duration per Finger	76
5.74. Box Plot Finger Capture Duration Comparison	77
5.75. Top and Bottom Locations by Finger Acquisition Duration	77
5.76. Evaluation Finger Capture Duration	78
5.77. Stacked Bar Plot Relative Frequencies of Applicants with a Missing Finger	78
5.78. Stacked Bar Plot Relative Frequencies Missing Finger Reason	78
5.79. Histogram Number of Missing Fingers	79

5.80. Stacked Bar Plot Relative Frequencies Missing Fingers	79
5.81. Top and Bottom Locations by Relative Frequencies of at least one Missing Finger per Process	80
5.82. Evaluation Sequence Errors	80
5.83. Stacked Bar Finger Acquisitions With Sequence Errors	80
5.84. Histogram Number of Sequence Errors	81
5.85. Evaluation Segmentation Errors	81
5.86. Stacked Bar Finger Acquisitions With Segmentation Errors	81
5.87. Evaluation Uniqueness Checks	82
5.88. Stacked Bar Uniqueness Check Errors per Finger Acquisition	82
5.89. Stacked Bar Finger Duplicates	82
5.90. Top and Bottom Locations by Number of Uniqueness Check Errors	83
5.91. Evaluation NFIQ 2.0 Fingerprint Image Quality	83
5.92. Stacked Bar Plot Relative Finger Quality Assessment Errors	84
5.93. Histogram NFIQ 2.0 Fingerprint Image Quality	84
5.94. Box Plot NFIQ 2.0 Fingerprint Image Quality Finger Comparison	85
5.95. Evaluation Finger Presentation Attack Detection	85
5.96. Stacked Bar Finger Acquisitions with Presentation Attack Detection	86
5.97. Top and Bottom Locations by Activation of Presentation Attack Detection	86
5.98. Top and Bottom Locations by Detected Presentation Attack Detection	86
5.99. Histogram Number of Presentation Attack Detection Scores	87
5.100.Required Evaluations EVA-FP-AAD	87
5.101.Evaluation Facial Image Capture Component	88
5.102.Heat Map Facial Image Acquisitions by Software	88
5.103.Heat Map Facial Image Acquisitions by Hardware	89
5.104.Evaluation Facial Image Acceptability	89
5.105.Stacked Bar Plot Total Facial Image Quality	90
5.106.Stacked Bar Plot Acceptability of Facial Images by Quality Metrics	90
5.107.Top and Bottom Locations by Total Acceptability of Facial Images	91
5.108.Evaluation Facial Image Central Acceptability	91
5.109.Stacked Bar Plot Total Central Facial Image Quality	92
5.110.Stacked Bar Plot Central Acceptability of Facial Images by Quality Metrics	92
5.111.Required Evaluations EVA-FI-AAD	93

1. Introduction

This document describes Application Profiles, Function Modules and Partial Application Profiles. For an overview of this Technical Guideline, consult TR-03121, Part 1 "Framework".

1.1. Business Process Modelling Notation (BPMN)

The processes in this Technical Guideline are modelled using the Business Process Modelling Notation (BPMN). Figure 1.1 gives an overview over the relevant icons herein.

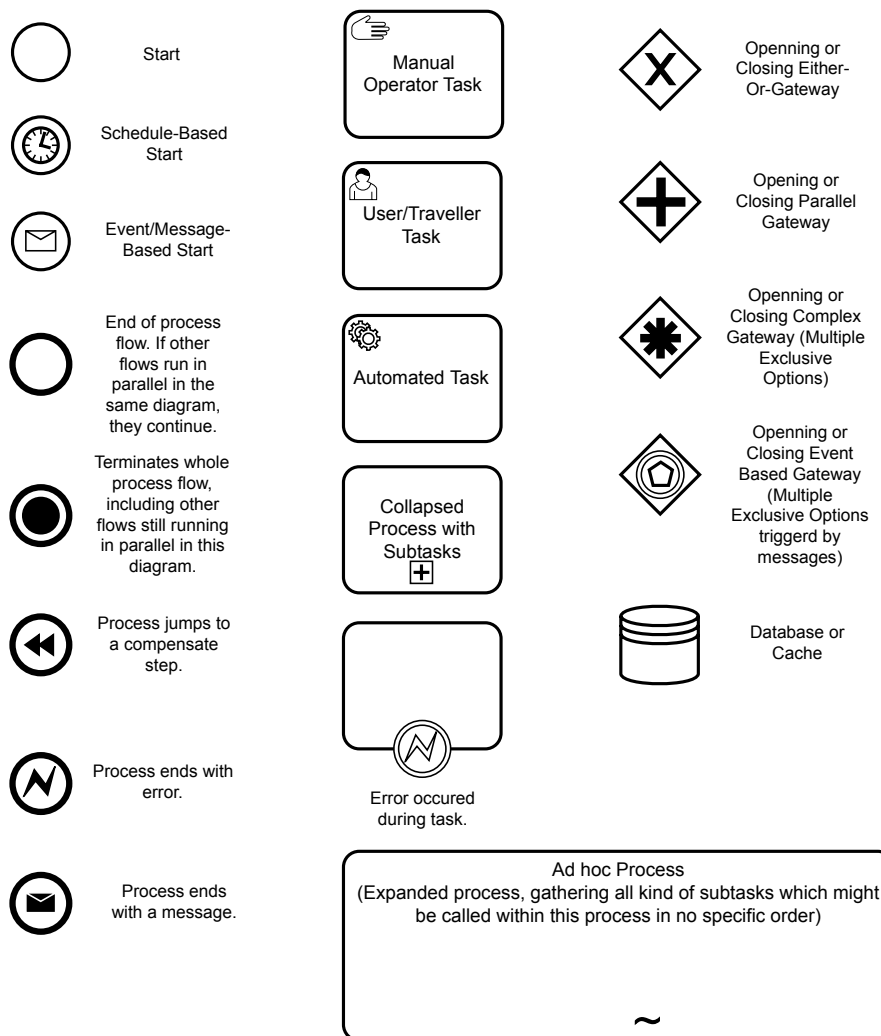

Figure 1.1. BPMN-icons Used for the Process Modelling

2. Volume Documents for Asylum Seekers

This document defines Application Profiles for the enrolment of biometric data for Identity Documents of asylum seekers.

3. Application Profiles

3.1. Application Profile Arrival Attestation Document

The following Application Profile describes the application for an Arrival Attestation Document. Function Modules may have additional transition rules for their requirements.

The requirements for the application and issuance of an Arrival Attestation Document are determined by national law [AsylG] §63a according to [AKNV].

By legal requirements, the enrolment of the applicants facial image and fingerprints (only for applicants 14 years of age or older) is mandatory. In addition to the issued document, the recorded information must be transferred to the central register of foreigners (according to [AZRG] §3 and [AZRGDV] §5).

3.1.1. System Overview

The main components in this context consist of the Central Identity Register (CIR), the Biometric Evaluation Authority (BEA) and the local registration office as depicted in Figure 3.1. Any request for biometric and biographic data retrieval or storage is performed via the CIR, which connects and proxies further background systems. The BEA represents the destination for log files documenting the process in detail. The applicant appears in person at the local registration office, where an official operates the live enrolment equipment and guides the process.

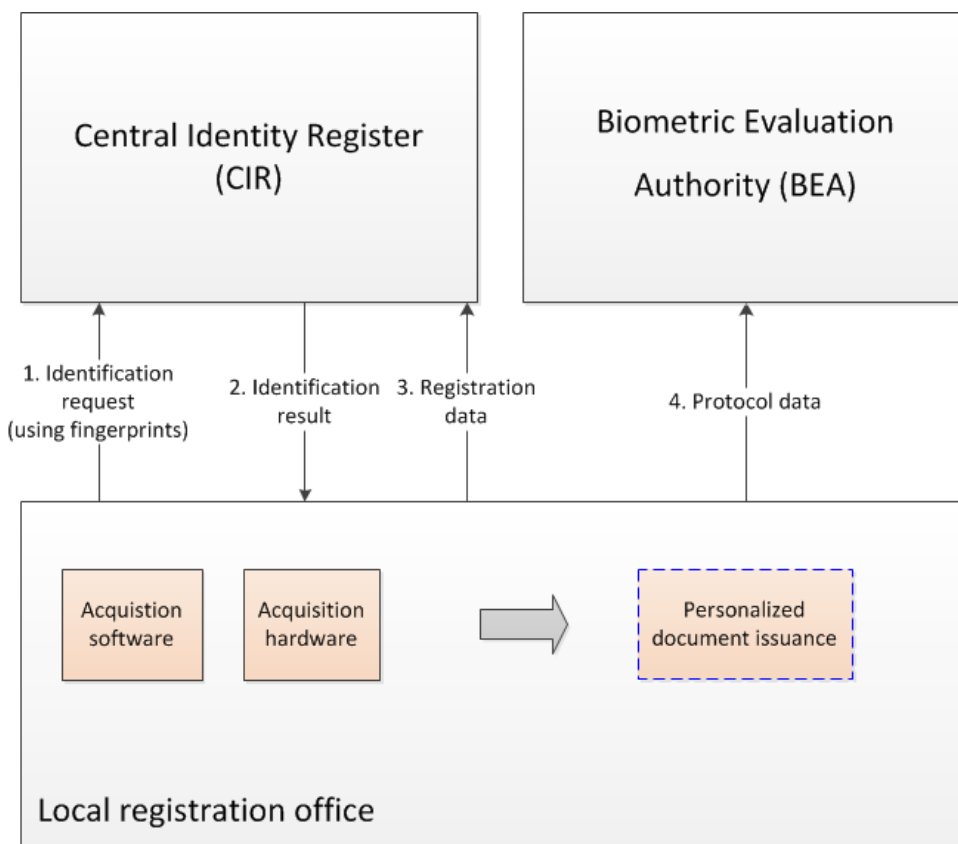

Figure 3.1. System Architecture Overview

In the depicted architecture the CIR comprises of the central register of foreigners (operated by Federal Office of Administration) in conjunction with the Automated Fingerprint Identification System (operated by Federal Criminal Office). The BEA is also operated by the Federal Office of Administration.

3.1.2. Mandatory Process

In general, two different scenarios exist, refer to Figure 3.2: One scenario is the pre-registration with storage of the applicant's biographic and biometric data in the CIR. The issuance of the Arrival Attestation Document is performed at any registration office later on in a separate process by retrieving the already existing data from the CIR. In the other scenario, the process consists of both biographic and biometric data assessment and the immediate subsequent issuance of the document.

In any case, the main process SHALL begin with an initial identification request to the CIR. Up to ten plain fingerprints SHALL be captured from the applicant and sent to the CIR in order to perform a biometric identification and check whether the applicant has already been registered upfront. The returned result is either empty or contains a set of identification results.

In case the identification fails, i.e. no record is returned from the CIR, a new data record for the applicant SHALL be created and subsequently sent to the CIR for storage. Therefore, additionally rolled fingerprints SHALL be captured. A biometric cross-verification with the previously plain captured fingerprints ("control prints") SHALL be used as Quality Assessment (QA) in this process.

In case one or more facial images of the applicant are present in a retrieved record, they SHALL be assessed in regard to quality requirements and re-usability for the issuance of the Arrival Attestation Document. If no facial image is available from the CIR, a high quality image SHALL be captured live by the operating official using a digital camera with subsequently applied QA.

The applicants biographic and biometric data including process and quality information are coded and passed to the calling application, which directs the data to the back-end system for enrolment.

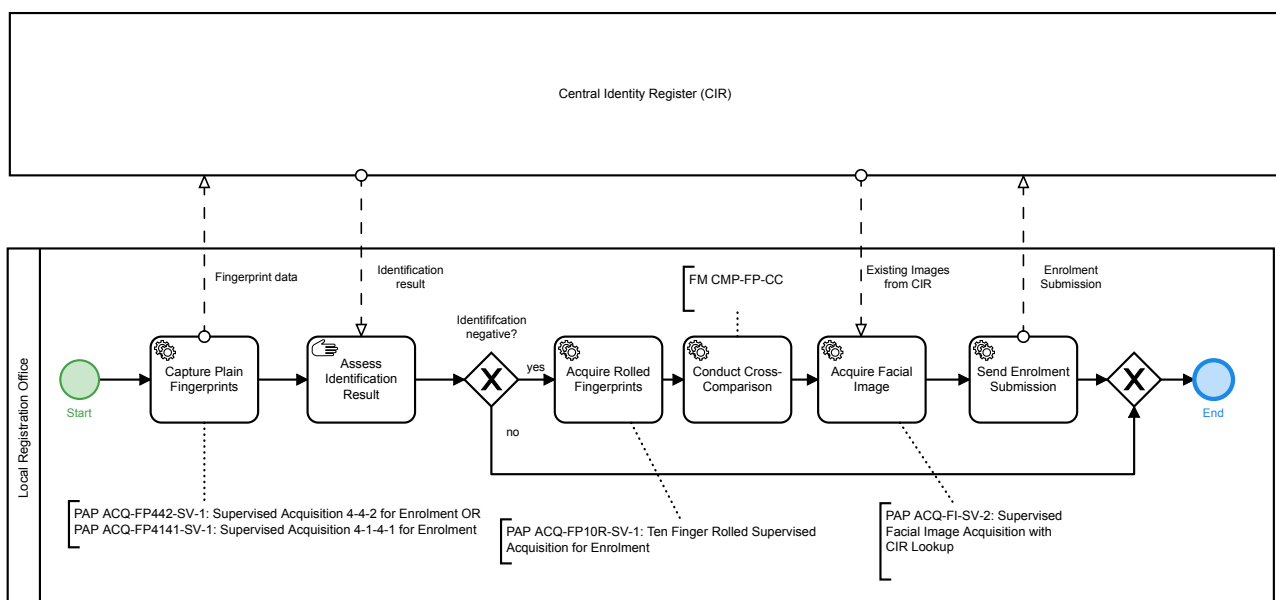

Figure 3.2. Process Overview

3.1.3. Relevant Standards and Conditions

In addition to the legal requirements, further basic directives and standards are applicable.

- [GSAT3]
- [ISO_FACE_2011]

3.1.4. Mandatory Function Modules

All Function Modules which SHALL be applied for the Application Profile are presented in Table 3.1 whereby slash separated entries denote alternative Function Modules and comma-separated entries denote requirements for all specified Function Modules.

Module Category	Required Function Modules
Acquisition Hardware	FM AH-FI-DC FM AH-FP-OPT
Acquisition Software	FM AS-FI-DC FM AS-FP-MF, FM AS-FP-ROLL
Biometric Image Processing	FM BIP-FI-DC-HQ FM BIP-FP-APP
Quality Assessment	FM QA-FI-PG, FM QA-FI-SB FM QA-FP-APP
Presentation Attack Detection	FM PAD-FP-APP1
Compression	FM COM-FI-JPG FM COM-FP-WSQE
Operation	FM O-FI-ALL FM O-FI-DC FM O-FP-ALL
User Interface	FM UI-FI-OP, FM UI-FI-BSJ FM UI-FP-OP, FM UI-FP-BSJ
Reference Storage	FM REF-FP-AAD FM REF-FI-AAD
Biometric Comparison	FM CMP-FP-CC
Logging	FM LOG-ALL-GENERIC, FM LOG-ALL-AAD FM LOG-FI-GENERIC FM LOG-FP-GENERIC
Coding	FM COD-ALL-AAD FM COD-FI-GSAT3 FM COD-FP-GSAT3
Evaluation	FM EVA-ALL-AAD

Module Category	Required Function Modules
	FM EVA-FI-AAD
	FM EVA-FP-AAD

Table 3.1. Required Function Modules Application Profile Arrival Attestation Document

3.1.5. Mandatory Partial Application Processes

All Partial Application Processes which SHALL be applied for the Application Profile are presented in Table 3.2 whereby slash separated entries denote alternative Partial Application Processes and comma-separated entries denote requirements for all specified Partial Application Processes.

No.	Required Partial Application Process
1	PAP ACQ-FP10R-SV-1: Ten Finger Rolled Supervised Acquisition for Enrolment
2	PAP ACQ-FP442-SV-2: Supervised Acquisition 4-4-2 for Enrolment without Fall-back Single Finger Acquisition/PAP ACQ-FP4141-SV-2: Supervised Acquisition 4-1-4-1 for Enrolment without Fall-back Single Finger Acquisition
3	PAP ACQ-FI-SV-2: Supervised Facial Image Acquisition with CIR Lookup

Table 3.2. Required Partial Application Processes Application Profile Arrival Attention Document

4. Partial Application Processes

The Partial Application Process (PAP) specified by the following sections provide process specifications of basic biometric processes, e.g. the acquisition, identification or verification of biometrics or the evaluation processes for verification and identification. The processes are referenced by the relevant Application Profiles and are part of the overall processes specified by the relevant Application Profiles.

A PAP MAY also be a task. A task is a process which functions as a generic reusable building block which is used by another PAP and is not referenced by an Application Profile directly.

The specific Function Modules which SHALL be applied for the processes specified in this chapter are specified by the relevant Application Profile. This MAY include FM Category Presentation Attack Detection, FM Category Biometric Image Processing, FM Category Acquisition Hardware, FM Category Acquisition Software, FM Category Biometric Comparison, FM Category Compression, FM Category Logging, FM Category Evaluation, FM Category Reference Storage, FM Category User Interface, FM Category Quality Assessment, FM Category Operation, and FM Category Coding.

4.1. General Process Requirements

The following requirements apply for all process specification in general.

4.1.1. Requirements

Multiple lossy compressions of facial image data SHALL NOT be allowed within any specified process with the exception of the initial capture by a digital camera whenever that camera does not support uncompressed image capture¹.

For rolled fingerprint acquisitions processes, each captured fingerprint SHALL be compared with a plain image of the same finger segmented from a corresponding control slap.

4.1.2. Recommendations

It is RECOMMENDED that the verifications conducted during sequence checks comply with FM Category Biometric Comparison.

4.2. PAP ACQ-FI-SV-2: Supervised Facial Image Acquisition with CIR Lookup

The facial image acquisition process described in this section REQUIRES a supervised situation and a CIR which MAY already contain a facial image of the biometric subject. Thus, two options of how an image can be obtained of the biometric subject are available, refer to Figure 4.1:

1. The biometric subject's facial image is captured using live enrolment equipment (including a digital camera within a photo studio setup) operated by an operator².
2. One or more facial images of the biometric subject already exist in the CIR and can be retrieved to be examined for re-use.

In the first case, a facial image of the biometric subject is taken live by the operator operator using a digital camera. An immediately performed software quality assessment (QA) for the captured facial image ensures

¹See detailed requirements in FM Category Acquisition Hardware for further information.

²See ISO/IEC 19794-5, Annex B for "Best practices for Face Images"

its biometric usability. If the quality assessment succeeds positively, the facial image is released to the calling software. If the quality is assessed as insufficient, the operator can recapture or has the option to put a veto in order to accept the captured facial image despite the negative software decision. In case of an overruling veto, the facial image is accepted and released to the calling application. In the negative case, the facial image is discarded and a re-capture is performed.

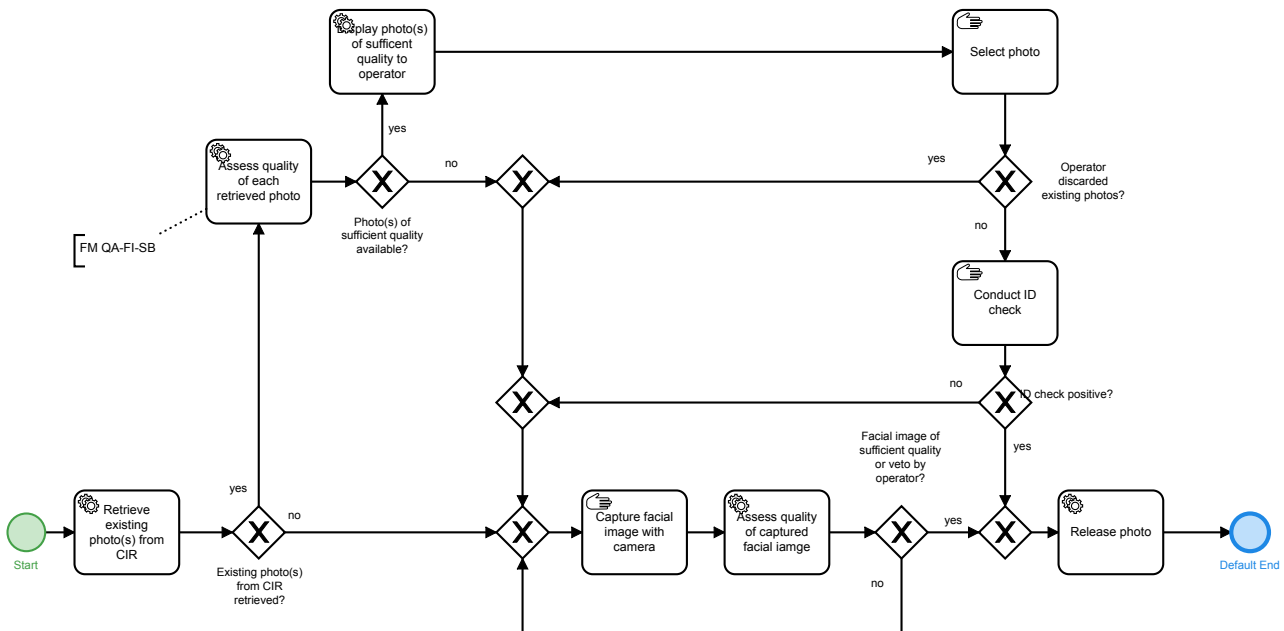

Figure 4.1. Partial Application Process "Supervised Facial Image Acquisition Process with CIR Lookup"

In case one or more facial images of the biometric subject are available in the CIR, they can potentially be reused for the issuance of the document. In case the CIR does provide information about the capture date or date of storing the facial image in the CIR, only facial images SHALL be retrieved not dated older than six months by capture date or date of storing the facial image in the CIR. The quality of each retrieved facial image SHALL be assessed by the software in regard to quality requirements and usability for the purpose of enrolment. After the images were processed by the software quality assessment (QA), they are displayed to the operating operator for selection via the graphical user interface (GUI) of the software in order to be selected for release. Thereby, only those images are displayed which pass the quality assessment with a positive result. In case none of the retrieved images are considered to be of sufficient quality a live facial image SHALL be captured (see first case). The operator SHALL always have the option to put a veto to not select any of the retrieved facial images despite sufficient quality or to put a veto to select an image of insufficient quality.

4.3. PAP ACQ-FP442-SV-2: Supervised Acquisition 4-4-2 for Enrolment without Fall-back Single Finger Acquisition

Figure 4.2 depicts the capture process for the 4-4-2 enrolment scenario where no single finger acquisition as fall-back is allowed. Note, that the PAP Task ACQ-FPS-SV-2: Capture Slap Supervised without Fall-back Single Finger Acquisition is used here. The 4-4-2 sequences are described in detail subsequently:

1. acquire right hand: index finger, middle finger, ring finger, little finger
2. acquire left hand: index finger, middle finger, ring finger, little finger
3. thumbs of both hands (simultaneously)

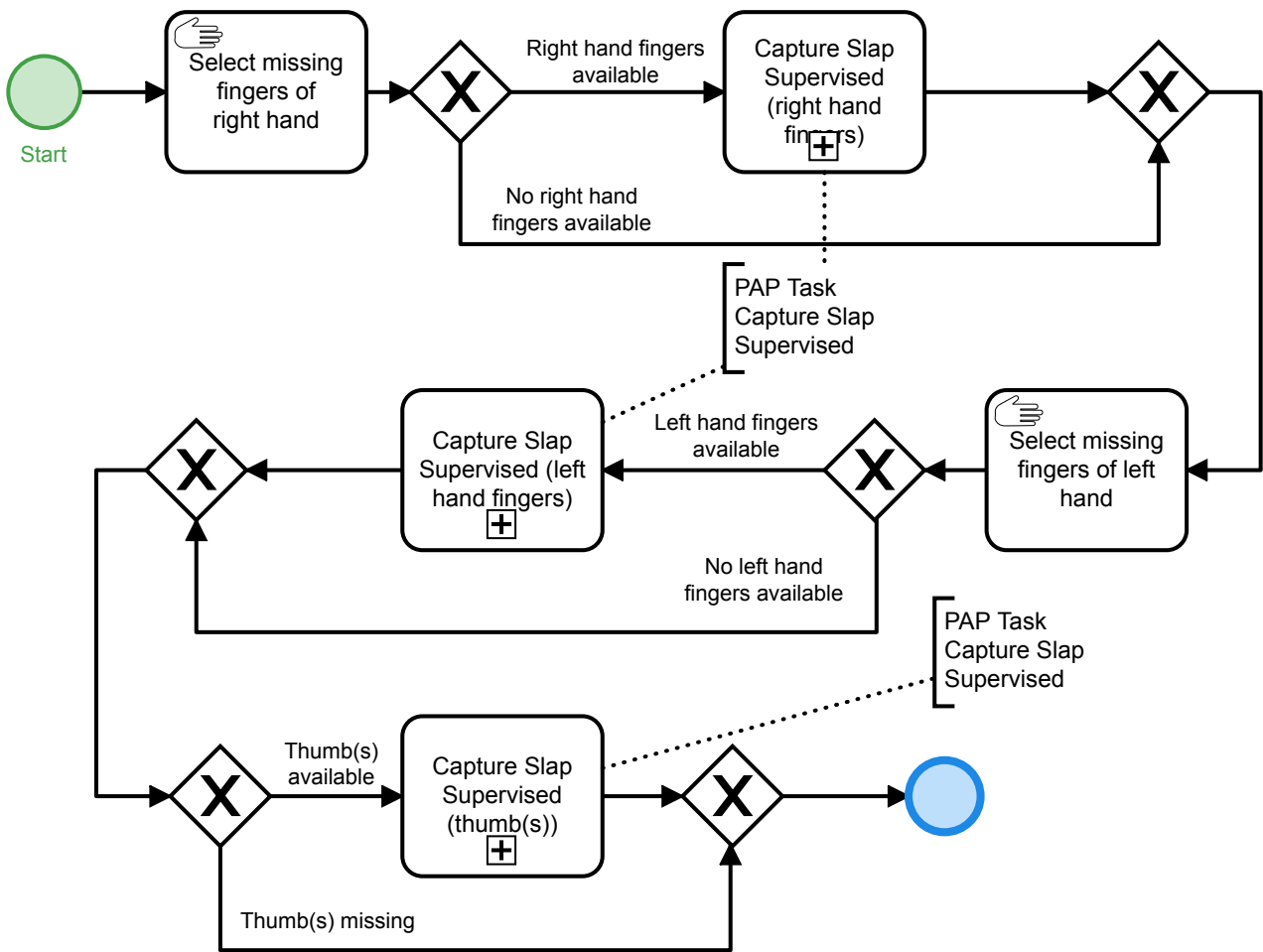

Figure 4.2. Partial Application Process "Supervised Acquisition 4-4-2 for Enrolment without Fall-back Single Finger Acquisition"

4.3.1. PAP Task ACQ-FPS-SV-2: Capture Slap Supervised without Fall-back Single Finger Acquisition

Figure 4.3 depicts the basic process for a plain supervised slap capture. A plain slap capture can be part of more complex acquisition processes, e.g. a ten finger acquisition by the 4-1-4-1 capture sequence. The plain slap capture is subsequently described in detail. The quality assessment is conducted according to the requirements of the applicable FM Category Quality Assessment.

1. The counter variable for the number of attempts for capturing the current slap SHALL be initialized as $i = 1$.
2. The slap image SHALL be retrieved from hardware.
3. The fingerprints SHALL be segmented and each SHALL be assessed.
 - a. In case the quality of the fingerprints meets the quality requirements defined in the corresponding QA Function Module, the captured slap and the set of segmented fingerprints and parameter data (e.g. quality values) SHALL be temporarily stored.
 - b. In case the quality requirements for one or more fingerprints of the slap are not met, the capture SHALL be repeated up to two times (i.e. the acquisition of a single slap consists of a maximum of three capture attempts).

4. A sequence check SHALL be conducted for the captured slap image to detect the capture of wrong fingers, e.g. due to interchanged hands or multiple acquisition of the same hand or finger. Note, that it is RECOMMENDED to conduct the sequence check as early as possible after a fingerprint image is available.
 - a. In case the comparison of any finger of the current slap with any previously accepted finger of a previous slap is successful, the sequence check SHALL throw an error.
 - b. In case the comparisons of all fingers of the current slap with all fingers of previous slaps are not successful, the sequence check SHALL throw no error.

If the quality check of the third capture attempt fails, the best of the captured slaps SHALL be identified according to the corresponding QA Function Module and temporarily stored along with corresponding information.

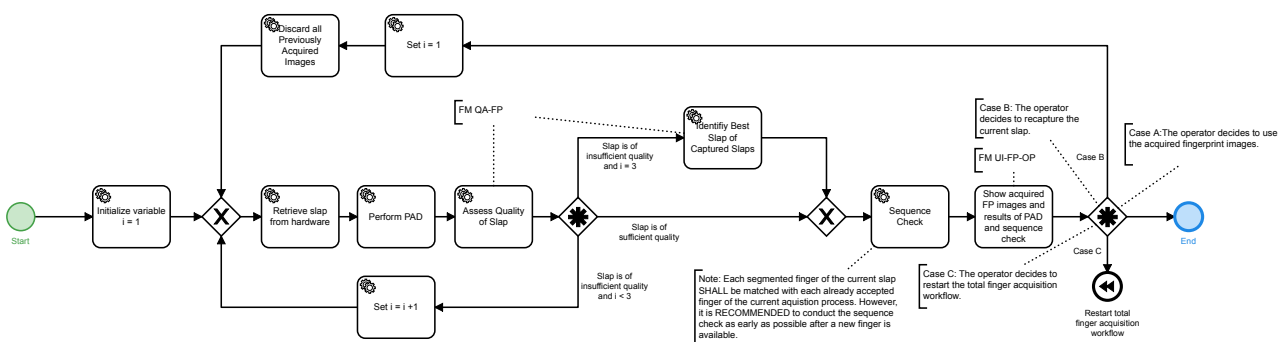

Figure 4.3. Partial Application Process Task "Capture Slap Supervised without Fall-back Single Finger Acquisition"

4.4. PAP ACQ-FP4141-SV-2: Supervised Acquisition 4-1-4-1 for Enrolment without Fall-back Single Finger Acquisition

Figure 4.4 depicts the acquisition process for 4-1-4-1 the enrolment scenarios. Note, that the PAP Task ACQ-FPS-SV-2: Capture Slap Supervised without Fall-back Single Finger Acquisition is used here. The 4-1-4-1 sequence is described in detail subsequently:

1. capture right hand: index finger, middle finger, ring finger, little finger
2. capture right hand: thumb
3. capture left hand: index finger, middle finger, ring finger, little finger
4. capture left hand: thumb

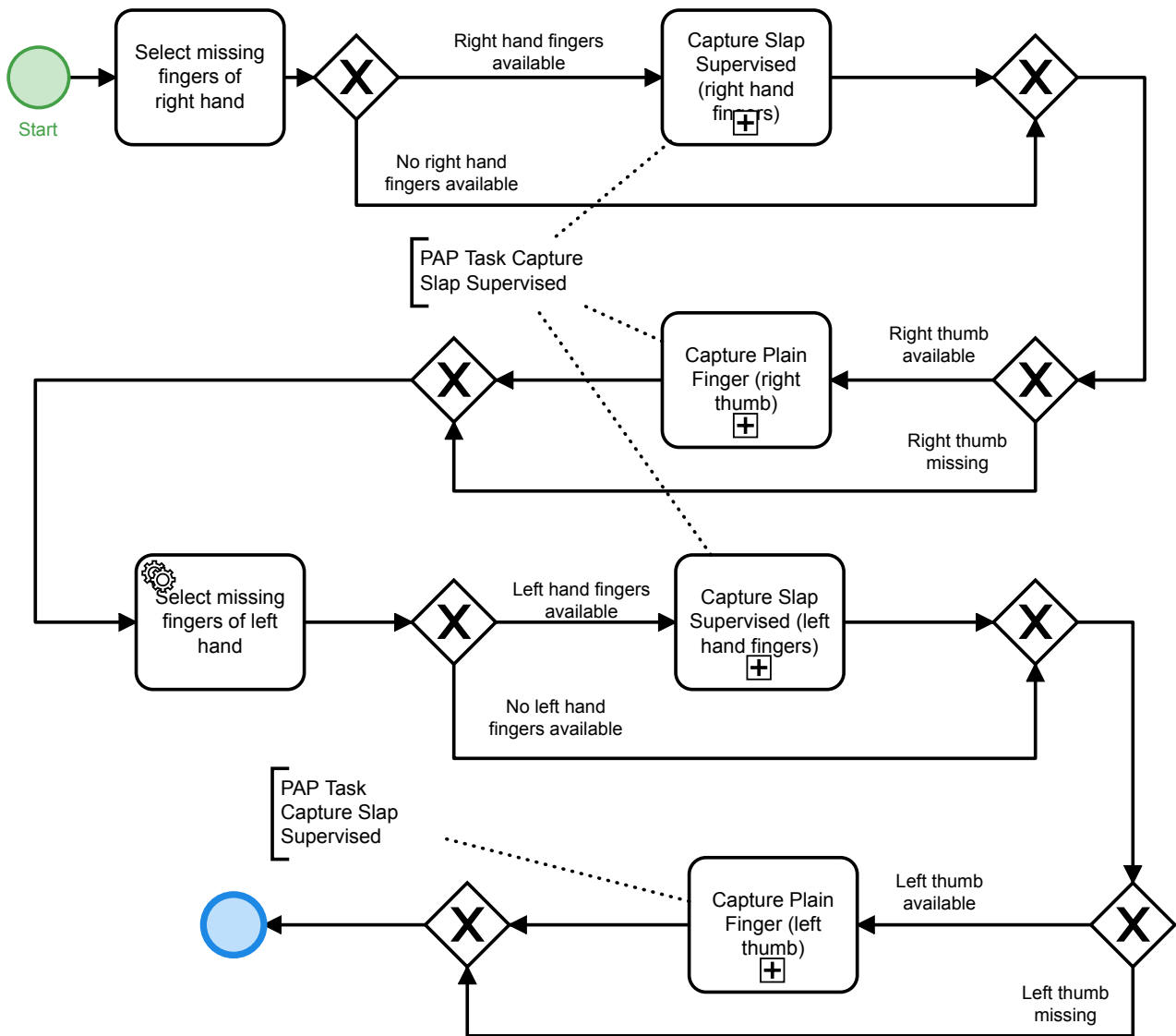

Figure 4.4. Partial Application Process "Supervised Acquisition 4-1-4-1 for Enrolment without Fall-back Single Finger Acquisition"

4.4.1. PAP Task ACQ-FPS-SV-2: Capture Slap Supervised without Fall-back Single Finger Acquisition

Figure 4.3 depicts the basic process for a plain supervised slap capture. A plain slap capture can be part of more complex acquisition processes, e.g. a ten finger acquisition by the 4-1-4-1 capture sequence. The plain slap capture is subsequently described in detail. The quality assessment is conducted according to the requirements of the applicable FM Category Quality Assessment.

1. The counter variable for the number of attempts for capturing the current slap SHALL be initialized as $i = 1$.
2. The slap image SHALL be retrieved from hardware.
3. The fingerprints SHALL be segmented and each SHALL be assessed.

- a. In case the quality of the fingerprints meets the quality requirements defined in the corresponding QA Function Module, the captured slap and the set of segmented fingerprints and parameter data (e.g. quality values) SHALL be temporarily stored.
 - b. In case the quality requirements for one or more fingerprints of the slap are not met, the capture SHALL be repeated up to two times (i.e. the acquisition of a single slap consists of a maximum of three capture attempts).
4. A sequence check SHALL be conducted for the captured slap image to detect the capture of wrong fingers, e.g. due to interchanged hands or multiple acquisition of the same hand or finger. Note, that it is RECOMMENDED to conduct the sequence check as early as possible after a fingerprint image is available.
- a. In case the comparison of any finger of the current slap with any previously accepted finger of a previous slap is successful, the sequence check SHALL throw an error.
 - b. In case the comparisons of all fingers of the current slap with all fingers of previous slaps are not successful, the sequence check SHALL throw no error.

If the quality check of the third capture attempt fails, the best of the captured slaps SHALL be identified according to the corresponding QA Function Module and temporarily stored along with corresponding information.

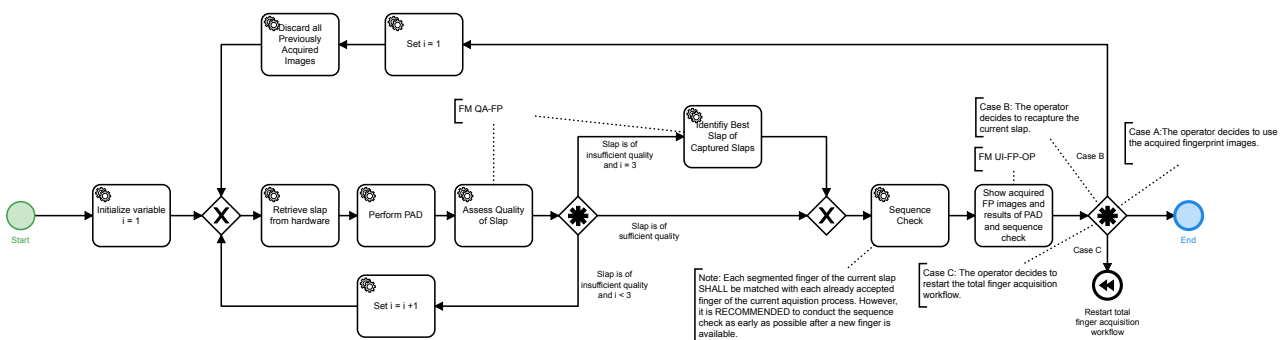

Figure 4.5. Partial Application Process Task "Capture Slap Supervised without Fall-back Single Finger Acquisition"

4.5. PAP ACQ-FP10R-SV-1: Ten Finger Rolled Supervised Acquisition for Enrolment

Figure 4.6 depicts the acquisition process for ten rolled fingers. Note, that the PAP Task ACQ-FPR-1: Capture Rolled Finger is used here. The sequence is described in detail subsequently:

1. The missing fingers are selected.
2. Each finger is captured according to "Capture Rolled Finger" process
3. In case the finger to be captured is not available (e.g. due to injury), the current capture is skipped

When all available fingers have been captured, the process finishes.

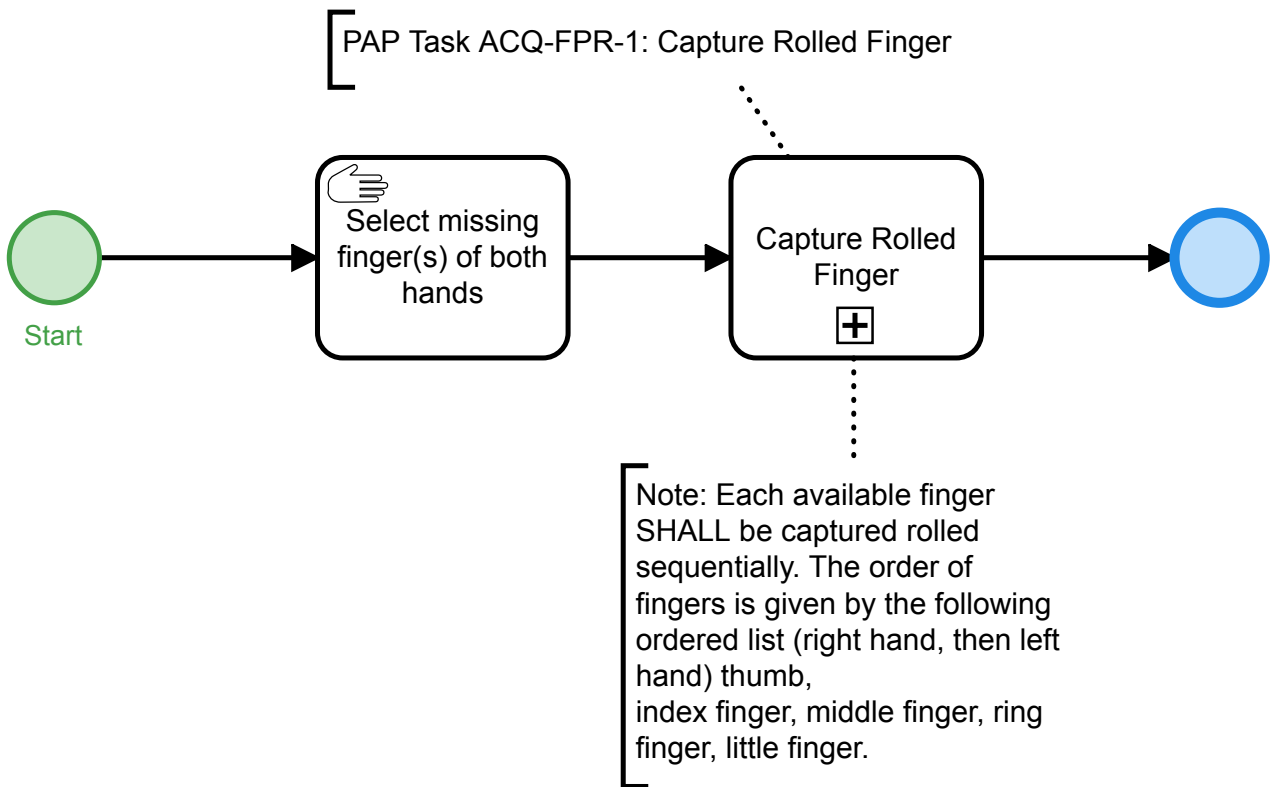

Figure 4.6. Partial Application Process "Supervised Acquisition Process Ten Rolled Fingerprints for Enrolment"

4.5.1. PAP Task ACQ-FPR-1: Capture Rolled Finger

Figure 4.7 defines the basic sequence for a rolled fingerprint capture. The basic sequence for a rolled fingerprint capture can be part of more complex acquisition processes, e.g. a ten finger rolled acquisition. The basic sequence for a rolled fingerprint capture is described in detail subsequently. The quality assessment is conducted according to the requirements of the applicable Section 5.4.

1. The counter variable for the number of attempts for capturing is initialized as $i = 1$.
2. The rolled fingerprint images is retrieved from the acquisition hardware.
3. If the hardware reports an issue of the rolling process, the capture SHALL be repeated if $i < 3$ and i is increased by 1.
4. If no hardware reported issue was found, quality assessment SHALL ensure proper quality of the captured fingerprint.
 - a. In case the quality of the fingerprint meets the quality requirements defined in the corresponding QA Function Module, the captured fingerprint and parameter data (e.g. quality values) are temporarily stored and the capture of the current finger finishes.
 - b. In case the quality requirements of the rolled fingerprint is not met, the capture SHALL be repeated if $i < 3$ and i is increased by 1.
5. A control verification SHALL be conducted for each captured rolled image. Therefore, plain control slaps have to be captured in a workflow upfront. Note, it is RECOMMENDED to conduct the control verification as early as possible after a fingerprint image is available.
 - a. In case the comparison of the rolled finger and its corresponding plain finger is successful, the control verification is considered successful.

- b. In case the comparison of the rolled finger and its plain finger is not successful and the rolled finger is successfully compared with any other plain finger, the control verification is considered not successful.
 - c. In case no successful comparison of the rolled finger and any plain finger occurs, the control verification is considered undetermined.
6. The capture SHALL be repeated up to two times because of a hardware reported issues of the rolling process or quality issues. The operator SHALL be allowed to capture additional images if after the third attempt no fingerprint without hardware reported issue and sufficient quality was conducted.

If the quality check of the third capture attempt fails or the hardware reported an issue of the rolling process, the best of the previously captured images is identified according to the corresponding QA Function Module and temporarily stored along with corresponding information.

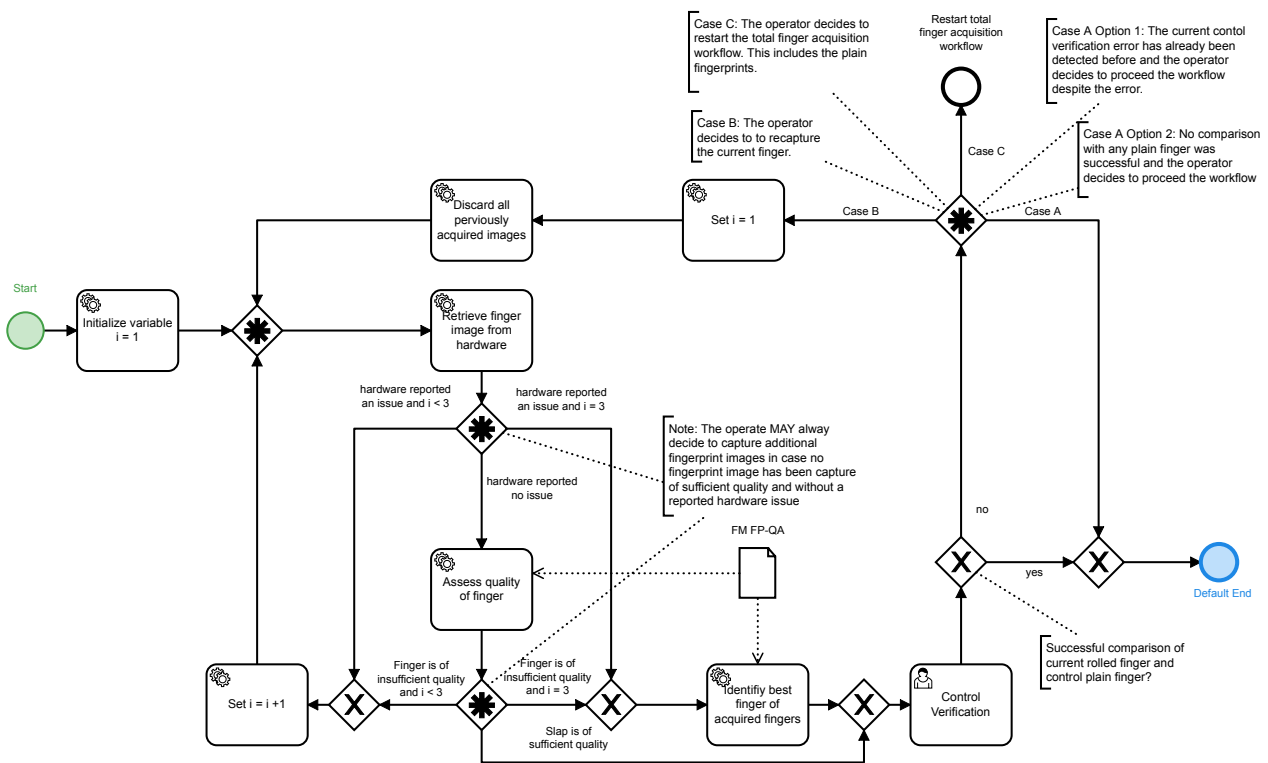

Figure 4.7. Partial Application Process Task "Capture Rolled Finger"

5. Function Modules

This chapter lists all the Function Modules (FMs) for the defined Application Profiles.

5.1. FM Category Acquisition Hardware

Devices that are used for digitising physical, representable biometric characteristics are called Acquisition Hardware (AH). Scanners for capturing photographs, digital cameras to capture images of the face, fingerprint sensors, or signature tablets can be named as examples.

5.1.1. FM AH-FI-DC

This Function Module describes the requirements for digital cameras and physical setup that are used to obtain facial biometrics.

5.1.1.1. Requirements

The following requirements SHALL be met:

- The minimum physical resolution of the camera SHALL allow a cropping of an image to 1600x1200 pixels without any up-scaling
- Adequate image quality to match requirements of [ISO_FACE] SHALL be provided.
- The physical and environmental conditions for capturing facial photos, such as the positioning of the camera, proper lighting of the face and a uniform background as described in Annex C of [ISO_FACE] SHALL be complied with.

5.1.2. FM AH-FP-OPT

This Function Module describes the requirements for high quality fingerprint scanners (single finger and multi finger).

5.1.2.1. Requirements

For the acquisition of the fingerprints, optical sensors using the principal of frustrated total reflection or direct contact (the imaging system is the sensor surface, typically separated by a transparent protection layer) according to setting level 31 or 41 in table 1 of [ISO_FINGER] (especially this means a resolution of 500 ppi or 1000 ppi) SHALL be used exclusively.

For the acquisition of the fingerprints, only devices are permitted which meet the following requirements (in analogy to [EBTS/F]). Notwithstanding, a capturing area of at minimum 16 mm width and 20 mm height is REQUIRED (deviating from table F 1 in [EBTS/F]) for single finger scanners.

5.1.2.1.1. Grey Scale Linearity

When measuring a stepped series of uniform target reflectance patches ("step tablet") that substantially covers the scanner's grey range, the average value of each patch SHALL be within 7.65 grey levels of a linear, least squares regression line fitted between target reflectance patch values (independent variable) and scanner output grey levels of 8 bit resolution (dependent variable).

5.1.2.1.2. Resolution and Geometrical Accuracy

Resolution: The scanner's final output fingerprint image SHALL have a resolution, in both sensor detector row and column directions, in the range: $(R - 0.01R)$ to $(R + 0.01R)$. The magnitude of R is either 500 ppi or

1000 ppi; a scanner MAY be certified at either one or both of these resolution levels. The scanner's true optical resolution SHALL be greater than or equal to R .

Across-Bar geometric accuracy: When scanning a 1.0 cy/mm, multiple parallel bar target, in both vertical bar and horizontal bar orientations, the absolute value of the difference (D) between the actual distance across parallel target bars (X), and the corresponding distance measured in the image (Y) SHALL NOT exceed the following values for at least 99 % of the tested cases in each print block measurement area and in each of the two directions:

- for 500 ppi scanners:

$$D \leq 0.0007, \text{ for } 0.00 < X \leq 0.07 \text{ and}$$

$$D \leq 0.01X, \text{ for } 0.07 \leq X \leq 1.50$$

- for 1000 ppi scanners:

$$D \leq 0.0005, \text{ for } 0.00 < X \leq 0.07 \text{ and}$$

$$D \leq 0.0071X, \text{ for } 0.07 \leq X \leq 1.50$$

where $D = |Y - X|$, X = actual target distance, Y = measured image distance (D , X , Y are in inches).

Along-Bar geometric accuracy: When scanning a 1.0 cy/mm, multiple parallel bar target, in both vertical bar and horizontal bar orientations, the maximum difference in the horizontal or vertical direction, respectively, between the locations of any two points within a 1.5 inch segment of a given bar image, SHALL be less than 0.016 inches for at least 99 % of the tested cases in each print block measurement area and in each of the two orthogonal directions.

5.1.2.1.3. Contrast Transfer Function

The spatial frequency response SHALL be measured using a binary grid target (Ronchi-Grating), denoted as contrast transfer function (CTF) measurement. When measuring the bar CTF, it SHALL meet or exceed the minimum modulation values defined by equation Equation 5.1 or equation Equation 5.2, in both the detector's row and detector's column directions, and over any region of the scanner's field of view. CTF values computed from equations Equation 5.1 and Equation 5.2 for nominal test frequencies are given in the following table. None of the CTF modulation values measured at specification spatial frequencies SHALL exceed 1.05. The output bar target image SHALL NOT exhibit any significant amount of aliasing.

Frequency [cy/mm]	Minimum Modulation for 500 ppi scanners	Minimum Modulation for 1000 ppi scanners	Maximum Modulation
1.0	0.948	0.957	1.05
2.0	0.869	0.904	1.05
3.0	0.791	0.854	1.05
4.0	0.713	0.805	1.05
5.0	0.636	0.760	1.05
6.0	0.559	0.716	1.05
7.0	0.483	0.675	1.05
8.0	0.408	0.636	1.05
9.0	0.333	0.598	1.05
10.0	0.259	0.563	1.05

Frequency [cy/mm]	Minimum Modulation for 500 ppi scanners	Minimum Modulation for 1000 ppi scanners	Maximum Modulation
12.0	---	0.497	1.05
14.0	---	0.437	1.05
16.0	---	0.382	1.05
18.0	---	0.332	1.05
20.0	---	0.284	1.05

Table 5.1. Minimum and Maximum Modulation

It is NOT REQUIRED that the bar target contains the exact frequencies listed in Table 5.1, however, the target does need to cover the listed frequency range and contain bar patterns close to each of the listed frequencies. The following equations are used to obtain the minimum acceptable CTF modulation values when using bar targets that contain frequencies not listed in Table 5.1:

- 500 ppi scanner, for $f = 1.0$ to 10.0 cy/mm:

$$CTF = 3.04105 \cdot 10^{-4} \cdot f^2 - 7.99095 \cdot 10^{-2} \cdot f + 1.02774 \quad (5.1)$$

- 1000 ppi scanner, for $f = 1.0$ to 20.0 cy/mm:

$$CTF = -1.85487 \cdot 10^{-5} \cdot f^3 + 1.41666 \cdot 10^{-3} \cdot f^2 - 5.73701 \cdot 10^{-2} \cdot f + 1.01341 \quad (5.2)$$

For a given bar target, the specification frequencies include all of the bar frequencies which that target has in the range 1 to 10 cy/mm (500 ppi scanner) or 1 to 20 cy/mm (1000 ppi scanner).

5.1.2.1.4. Signal-to-Noise Ratio and the Grey-Level Uniformity

The white signal-to-noise ratio (SNR) and black SNR SHALL each be greater than or equal to 125.0, in at least 97 % of respective cases, within each measurement area.

The grey level uniformity is defined for the three following cases:

- Adjacent row, column uniformity: At least 99 % of the average grey levels between every two adjacent quarter-inch long rows and 99 % between every two adjacent quarter-inch long columns, within each imaged area, SHALL NOT differ by more than 1.0 grey levels when scanning a uniform low reflectance target, and SHALL NOT differ by more than 2.0 grey levels when scanning a uniform high reflectance target.
- Pixel to pixel uniformity: For at least 99.9 % of all pixels within every independent 0.25 inch by 0.25 inch area located within each imaged area, individual pixel's grey level SHALL NOT vary from the average by more than 22.0 grey levels, when scanning a uniform high reflectance target, and SHALL NOT vary from the average by more than 8.0 grey levels, when scanning a uniform low reflectance target.
- Small area uniformity: For every two independent 0.25 inch by 0.25 inch areas located within each imaged area, the average grey levels of the two areas SHALL NOT differ by more than 12.0 grey levels when scanning a uniform high reflectance target, and SHALL NOT differ by more than 3.0 grey levels when scanning a uniform low reflectance target.

5.1.2.1.5. Grey Scale Range of Fingerprint Images

A fingerprint scanner operating at 500 ppi or 1000 ppi, SHALL perform the following sets of live scans:

- For a standard roll and plain finger live scanner: capture a complete set of fingerprints from each of 10 subjects; i.e. 10 rolls (all 5 fingers from each hand), 2 plain thumb impressions, and 2 plain 4-finger impressions.

- For a palm scanner component of a live scan system: capture left and right palms from each of 10 subjects.
- For an identification flat live scanner: capture left and right 4-finger plain impressions and dual thumb plain impressions from each of 10 subjects.

Within the histogram of each image all grey values with at least 5 Pixels in this image are counted. The histogram SHALL show no break and no other artefact. At least 80 % of the captured individual fingerprint images SHALL have a grey scale dynamic range of at least 200 grey levels, and at least 99% SHALL have a dynamic range of at least 128 grey levels.

5.2. FM Category Acquisition Software

Acquisition Software (AS) contains all functionality regarding image processing except for biometric purposes. Therefore, this Function Module usually contains device driver software for the acquisition hardware or, in general, software that is very close to the physical hardware such as firmware. Furthermore, colour management and image enhancement mechanisms are part of this software layer.

5.2.1. FM AS-FI-DC

This function block describes the requirements and interfaces for Acquisition Software used for digital cameras in order to obtain digitised images.

5.2.1.1. Requirements

The following requirements SHALL be met:

- The image data SHOULD be provided without any compression in one of the following image formats: Windows Bitmap Format Version 3, JPEG Lossless, DNG (in combination with JPEG Lossless).
- If the acquisition device does not support a lossless mode, the image MAY alternatively be provided in JPEG mode with the minimal level of compression possible.
- In normal mode of operation, no compression artefacts SHALL be detectable in the image.

5.2.1.2. Recommendations

Acquisition Software that supports calibration procedures for the respective digital camera SHOULD be used (in particular colour management).

5.2.2. FM AS-FP-ROLL

This Function Module describes the requirements and interfaces for Acquisition Software for scanners supporting rolled fingerprint capture.

5.2.2.1. Requirements

The acquisition software SHALL support the acquisition of rolled fingerprints. Therefore, the following requirements apply:

1. The captured fingerprint image SHALL depict the fingerprint from nail to nail.
2. The captured fingerprint image SHALL depict a faithful reproduction of the fingerprint, especially in the areas where the rolled fingerprint overlaps with the corresponding plain print.
3. Uniform Depiction

- a. The captured fingerprint image SHALL not depict visible distortion or interruptions.
- b. The captured fingerprint image SHALL not depict puzzle effects such that parts of the fingerprint image are displaced from their actual position.
- 4. Clear Depiction
 - a. The captured fingerprint image SHALL clearly depict friction ridges.
 - b. The captured fingerprint image SHALL not depict blurring and smearing.
 - c. The captured fingerprint image SHALL clearly depict ridge pattern.
 - d. If features exists for the given fingerprint:
 - i. The captured fingerprint image SHALL clearly depict features.
 - ii. If loop features exists for the given fingerprint:
 - A. The captured fingerprint image SHALL clearly depict loop features (core and delta).
 - e. The captured fingerprint image SHALL clearly depict existing features at the border zone of the image.
- 5. Complete Fingerprint
 - a. The captured fingerprint image SHALL depict the fingerprint's upper part.
 - b. The captured fingerprint image SHALL depict the fingerprint's core area with ridge lines.
 - c. If delta features exists for the given fingerprint:
 - i. The captured fingerprint image SHALL depict the fingerprints delta features.
 - d. The captured fingerprint image SHALL depict the fingerprint's baseline (bottom area).
- 6. The captured fingerprint image SHALL be unrotated. Thus, the vertical axis of the fingerprint depicted in the captured image SHALL be in parallel with the fingerprint image's vertical axis.
- 7. The captured fingerprint image provided by Acquisition Software SHALL meet the criteria of fingerprints as described in [ISO_FINGER] (particularly chapter 7 "Image acquisition requirements"). The requirements according to Table 5.2 are MANDATORY.
- 8. The acquisition software SHALL detect and provide information about issues while rolling a finger which affect the quality of the captured fingerprint. Those information SHALL be considered as hardware reported issues in the capture process, see relevant PAP.

Setting Level	Scan Resolution Pixels/Centimeter (ppcm)	Scan Resolution Pixels/Inch (ppi)	Pixel Depth (bits)	Dynamic Range (Grey Levels)	Certification
31	197	500	8	200	EFTS/F
41	394	1000	8	200	EFTS/F

Table 5.2. Image Acquisition Settings Levels

5.2.3. FM AS-FP-MF

This Function Module describes the requirements and interfaces for acquisition software for multi finger scanners.

5.2.3.1. Requirements

The image provided by acquisition software SHALL meet the criteria of fingerprints as described in [ISO_FINGER] (particularly chapter 7 "Image acquisition requirements"). The requirements according to setting level 31 or 41 from Table 1 in [ISO_FINGER] are mandatory.

For the acquisition process, a pre-qualification of the fingerprints to prefer high quality SHALL be used. The activation of the acquisition SHALL occur automatically. The capture SHOULD prefer the highest quality image of a sequence, at least the last captured image (after time-out) of a sequence.

This functionality MAY be part of the hardware firmware and MAY NOT be available as separate software component.

The thresholds of the pre-qualification for performing a capture SHALL be documented by the vendor and be configurable by the system administrator.

In case further requirements demand for an export of the uncompressed fingerprint image data one of the following image formats SHALL be used:

- BMP
- PNG

5.3. FM Category Biometric Image Processing

The Function Module Biometric Image Processing (BIP) provides the extraction of all relevant biometric information from the data which is provided by the acquisition hardware or the acquisition software layer. Thus, a proprietary data block is transformed to a digital image of a biometric characteristic. In general, specific image processing for biometrics is addressed here.

5.3.1. FM BIP-FI-DC-HQ

This Function Module describes requirements and interfaces for Biometric Image Processing with respect to the output of digital cameras to obtain a high quality facial image that fulfils the ISO requirements.

5.3.1.1. General Requirements

As a result of the image processing of this module, a facial image SHALL be compliant to the requirements of full frontal images specified in [ISO_FACE]. The minimum distance between both eyes for capture positions of the applicant in the preferred area of the camera range SHALL be at least 120 pixel.

The image processing SHALL enclose cropping the facial image, resulting in images with a height/width ratio of 4:3. The general requirements for the image cropping in Table 5.3 SHALL apply to all images if no dedicated requirements are defined for a given use case in this Functional Module.

Depending on the requirements of the modules of Section 5.12, multiple differently cropped versions of the image might be created at this step of image processing.

Criterion	Value	Unit
Image height	1600	Pixel
Image width	1200	Pixel

Table 5.3. Requirements for the Size of Facial Images

5.3.1.2. Requirements GSAT Transactions

Requirements in Table 5.3 SHALL not apply for German Standard for AFIS Transactions (GSAT) transactions. The requirements in Table 5.4 SHALL apply to images used in GSAT transactions.

Criterion	Value	Unit
Image height	800	Pixel

Criterion	Value	Unit
Image width	600	Pixel

Table 5.4. Requirements for the Size of Facial Images in GSAT Transactions

5.3.1.3. Requirements on Printing

If the image is also used for printing to the target size of 45mm x 35mm, it SHALL be cropped equidistantly from the original 4:3 aspect ratio.

Note that for the purpose of biometric processing, the 45:35 image SHALL not be considered any further.

5.3.2. FM BIP-FP-APP

This Function Module describes requirements and interfaces for the biometric image processing to provide up to four single finger images for the subsequent reference storage or biometric comparison.

5.3.2.1. Requirements

The resolution of the fingerprint image has to be 500 ppi corresponding to Table 1 in [ISO_FINGER] and, therefore, MAY differ from the scan resolution.

Depending on the call to capture one, two, three or four fingerprints, this number of individual fingerprints SHALL be extracted from the input image and provided as single fingerprints.

Note: Segmentation for single finger scanners is OPTIONAL.

For this segmentation process, the following requirements SHALL be fulfilled:

- ability to accept rotated fingerprints in the same direction up to 45°
- rotated fingerprints in the same direction have to be corrected to be vertical
- segment the first part over the finger (fingertip)
- segmentation has to occur on uncompressed data

5.4. FM Category Quality Assessment

The Function Module QA contains all kinds of mechanisms and procedures to check the quality of the biometric data or to select the best quality data out of multiple instances.

5.4.1. FM QA-FI-PG

This function block describes requirements for a photo guideline that is used for Quality Assurance.

5.4.1.1. Recommendations

If the quality assurance is to be performed by a person, visual tools like a photo guideline MAY be used for support.

If the visual check is conducted with the photo guideline, it always SHALL be done even if the checks with the photo template and/or the QA software will be performed afterwards. A recent picture is required according to Annex A of [ISO_FACE].

If these basic criteria are not met, the image SHALL be rejected without any further checks by the software or the photo template.

In the case of the photo guideline, the following criteria SHALL be described, preferably using sample images for compliant and non compliant images (compare [ISO_FACE]):

- frontal pose
- neutral expression
- mouth closed
- eyes open
- no occlusion (glasses, hair, eye patch)
- eyes looking to the camera
- background uniformity (plainness, no textures, colour)
- no shadows
- no head coverings
- no further people / objects
- equally distributed lighting
- no shadows over the face
- no shadows in the eye-sockets
- no hot spots on skin
- no effects from glasses
- correct exposure
- correct contrast
- focus and depth of field
- no unnatural colours
- no red eyes

5.4.2. FM QA-FI-SB

This Function Module describes requirements and interfaces for software that is used for quality assessment of digital images to ensure compliance with [ISO_FACE].

5.4.2.1. Requirements

5.4.2.1.1. General Requirements

The QA module is used for the software-based automatic check of the conformance of the picture to [ISO_FACE] after the digitisation. Thereby, the geometric properties of the picture as well as the digital parameters of the image are analysed and rated.

The standard which is relevant for the quality of facial images [ISO_FACE] hierarchically describes requirements to the facial images. In the following, full frontal images are expected.

The QA module SHALL analyse and evaluate all of the quality criteria listed in Table 5.5. For the criteria marked with "M", the quality values SHALL be provided while quality values for the criteria marked with "O" MAY be provided in the defined format according to the respective criteria.

A criterion is fulfilled if its calculated value is in the given threshold boundaries.

Based on the results of all provided quality criteria the QA module SHALL reject or approve the picture. The total result is true if every single quality criteria is fulfilled.

The QA module SHALL provide an interface for conformance testing where a single image can be processed and the calculated values and configuration data are returned.

The QA module SHOULD operate on cropped images retrieved from the image processing according to FM Category Biometric Image Processing.

ID	Criterion	ISO-Ref. ^a	M/O ^b	Unit/Range
Pose of the head				
1.1	Yaw, neck axis	7.2.2	O	Degrees
1.2	Pitch, ear axis	7.2.2	O	Degrees
1.3	Roll, nose axis	7.2.2	M	Degrees
Facial expression				
2.1	Neutral expression	7.2.3	O	Arbitrary units
2.2	Mouth closed	7.2.3	M	Arbitrary units
2.3	No raised eyebrows	7.2.3	O	Arbitrary units
Eyes				
3.1	Eyes open	7.2.3	O	Arbitrary units
3.2	No occlusion (glasses, hair, eye patch)	7.2.11 7.2.12	O	Arbitrary units
3.3	Eyes looking to the camera	7.2.3	O	Arbitrary units
Background				
4.1	Uniformity (plainness, no textures, colour)	7.2.6 A.2.4.3	O	Arbitrary units
4.2	No shadows	7.2.6 A.2.4.2	O	Arbitrary units
4.3	No further people / objects	7.2.4 A.2.3	O	Arbitrary units
Geometry				
5.1	Image height	8.3.5 A.3.1.1 A.3.2.1	M	In pixel
5.2	Image width	8.3.4 A.3.1.1 A.3.2.1	M	In pixel
5.3	Ratio: Head width / image width	8.3.4	M	As ratio between 0 and 1
5.4	Ratio: Head height / image height	8.3.5	M	As ratio between 0 and 1
5.5	Vertical position of the face	8.3.3	M	As ratio between 0 and 1
5.6	Horizontally centred face	8.3.2	M	As ratio between 0 and 1
5.7	Eye distance	8.4.1 A.3.1.1	M	In pixel
Subject lighting				
6.1	Equally distributed lighting	7.2.7	O	Arbitrary units

ID	Criterion	ISO-Ref. ^a	M/O ^b	Unit/Range
6.2	No shadows over the face nor in the eye-sockets	7.2.8 7.2.9	O	Arbitrary units
6.3	No hot spots on skin	7.2.10	O	Arbitrary units
6.4	No effects on glasses	7.2.11	O	Arbitrary units
Geometry				
7.1	Proper exposure	7.3.2	M	Arbitrary units
7.2	Focus and depth of field	7.3.3	M	Arbitrary units
7.3	No unnatural colours	7.3.4	O	Arbitrary units
7.4	No red eyes	7.3.4	O	Arbitrary units
7.5	Colour space	7.4.2.3	M	According to [ISO_FACE] (e.g. "1" for RGB-24bit, "2" for YUV422 or "3" for 8bit-grey scale)
7.6	Grey scale density and colour saturation	7.4.2.1 7.4.2.2	M	Counted numbers of intensity values existing within the image

^aCompare [ISO_FACE]

^bMandatory / Optional

Table 5.5. Mapping of Relevant Quality Criteria

If defined, the thresholds for specific Application Profiles are detailed in Table 5.6.

ID	Criterion	Minimum	Maximum	Unit/Range
Image for passport chip (GID), ratio 45:35				
1.3	Roll, nose axis	-8	8	Degrees
5.1	Image height	521	541	In pixel
5.2	Image width	403	423	In pixel
5.3	Ratio: Head width / image width	0,5	0,75	As ratio between 0 and 1
5.4	Ratio: Head height / image height	0,6	0,9	As ratio between 0 and 1
5.5	Vertical position of the face	0,3	0,5	As ratio between 0 and 1
5.6	Horizontally centred face	0,45	0,55	As ratio between 0 and 1
5.7	Eye distance	90	-	In pixel
Image for Central Identity Register (AAD), ratio 4:3				
1.3	Roll, nose axis	-8	8	Degrees

ID	Criterion	Minimum	Maximum	Unit/Range
5.1	Image height	800	1600	In pixel
5.2	Image width	600	1200	In pixel
5.3	Ratio: Head width / image width	0,5	0,75	As ratio between 0 and 1
5.4	Ratio: Head height / image height	0,6	0,9	As ratio between 0 and 1
5.5	Vertical position of the face	0,3	0,5	As ratio between 0 and 1
5.6	Horizontally centered face	0,45	0,55	As ratio between 0 and 1
5.7	Eye distance	120	-	In pixel

^aFor quality criterion ID 5.5 "Vertical position of the face" the effective thresholds are [0,3; 0,5] according to the Technical Corrigenda of [ISO_FACE].

Table 5.6. Application Specific Thresholds for Facial Images^a

5.4.2.1.2. Requirements Identification of the Best Capture

When multiple captures of facial images and their corresponding set of quality metrics are passed, the best capture of the captures SHALL be identified as described in the following:

1. If exactly one facial image conforms to more mandatory criteria than all other images, this image is chosen.
2. If no image is conform to more mandatory criteria than all other images, the last temporal image with the most fulfilled mandatory criteria is chosen among the facial images fulfilling the most criteria. If no temporal information is available, a random selection SHALL be applied among the facial images fulfilling the most criteria

5.4.3. FM QA-FP-APP

This Function Module describes requirements for the quality assessment of plain or rolled fingerprints including quality assessment of single fingerprint, respectively slap and selection of the best quality image out of multiple instances.

5.4.3.1. Requirements

5.4.3.1.1. Quality Algorithm

As quality algorithm NFIQ 2.0 [NFIQ2.0] SHALL be used. As resulting quality value, the output value of NFIQ 2.0 in the integer range of [0,100] SHALL be used. In the case of failure, the returned value 255 indicates that a computation was not successful. In this case, the value SHALL be returned as dedicated error code.

5.4.3.1.2. Quality Evaluation Process for a Slap or Single Fingerprint

In case a single captured fingerprint, respectively slap is passed, the quality assessment SHALL be performed as described in the following. Beforehand, the fingerprints of the passed capture SHALL be segmented (considering missing fingers). Note, that in verification applications, a quality assessment is not conducted. Thus, every slap capture is considered sufficient and no thresholds are specified here.

1. For each segmented fingerprint $F_{A,j}$ of a passed capture A , a quality value $Q_{A,j}$ is calculated with $j \in 1, \dots, 10$ (up to 4 fingers in one slap) representing the specific finger code according to [ISO_FINGER].
2. The resulting quality value is compared with the defined threshold TH_j for this finger. The application specific thresholds as defined in the following section apply.
3. In case all of the fingerprint qualities reach the specified threshold (i.e. $\forall j, Q_{A,j} \geq TH_j$), the boolean information $b = 1$ indicates a successful capture.
4. In case one or more fingerprints do not reach the threshold (i.e. $\exists j, Q_{A,j} < TH_j$), the boolean information $b = 0$ indicates insufficient quality of the capture.
5. For the segmented fingerprint $F_{A,j}$ the corresponding parameter set $P_{A,j}$ is compiled and returned.
6. As a result of the quality assessment process, the following values are returned to the calling process:
 - a. the boolean information b
 - b. the parameter set $P_A = Q_{A,j}, \dots, Q_{A,l}$ with $j, l \in 1, \dots, 10$ representing the specific finger code

5.4.3.1.3. Identification of the Best Capture out of Multiple Captures

When multiple captures $A_i, i \in 1, \dots, n$ and their corresponding set of segmented fingerprints $F_{A_i,j}$ with $j \in 1, \dots, 10$ representing the specific finger code according to [ISO_FINGER] are passed, the best of the captures SHALL be identified as described in the following section:

1. For each segmented fingerprint $F_{A_i,j}$ of a passed capture A_i , the quality value $Q_{A_i,j}$ is calculated with representing the specific finger code according to [ISO_FINGER].
2. The captures are ranked according to the quality values of the fingerprints according to the following (lexicographical) order. The highest ranked capture is considered as the capture yielding the best quality.
 - a. for left/right four-finger slaps, the order is as follows:
 - i. index finger (highest priority)
 - ii. middle finger
 - iii. ring finger
 - iv. little finger (lowest priority)
 - b. for thumb slaps, the order is as follows:
 - i. right thumb (highest priority)
 - ii. left thumb (lowest priority)
 - c. for index finger slaps:
 - i. In contrast to the other two slap types, the best capture of index finger slaps is a set of the best captures of each index finger as indicated by the following two options.
 - ii. If each index finger yields sufficient quality in at least one of the already conducted captures, the index fingers of sufficient quality are accepted and the total index finger slap capture is considered as of sufficient quality.
 - iii. If not both index fingers yield at least once sufficient quality in a capture, the best image for each index finger is returned as the best capture and the slap captured is considered as of insufficient quality.
 - iv. If for a single slap both index fingers yield to sufficient quality, those two index fingers SHALL be selected even if an index finger of another slap yield to better quality.
 - d. for rolled single finger captures:
 - i. Of the set of captured images obtained in the process beforehand, which are not annotated by a hardware reported issue, the capture with the highest quality value is considered as the best image.
 - ii. If the set of captured images obtained in the process beforehand on does only contain images which are annotated by hardware reported issues, the capture with the highest quality value of the entire set is considered as the best image.
 - iii. In case several captures yield to the same highest quality value, the last (temporal) of highest quality captures is considered as the best image.

3. As a result of the quality assessment process, the following values are returned:
 - a. the identifier i representing the capture yielding the best quality
 - b. the parameter set $P_A = Q_{A_{i,j}}, Q_{A_{i,l}}$ with $j, l \in 1, \dots, 10$.

5.4.3.1.4. Thresholds for Plain Fingerprints for Enrolment Purposes

The following thresholds as indicated in Table 5.7 apply when fingerprints are captured plain for enrolment purposes. Note, the thresholds in Table 5.7 do not apply to plain captured fingerprint in enrolment scenarios where the plain fingerprints are captured for control purpose of rolled fingerprints. In that case, thresholds as indicated in Table 5.8 apply for the plain fingerprints.

Finger Position	Finger Code	NFIQ 2.0 Threshold
Right thumb	1	30
Right index finger	2	30
Right middle finger	3	20
Right ring finger	4	10
Right little finger	5	10
Left thumb	6	30
Left index finger	7	30
Left middle finger	8	20
Left ring finger	9	10
Left little finger	10	10

Table 5.7. Thresholds for Plain Fingerprints for Enrolment Purposes

5.4.3.1.5. Thresholds for Plain Control Fingerprints and Fingerprints used for Identification Searches

The following thresholds as indicated in Table 5.8 apply when fingerprints are captured plain for the purpose of control slaps (used for comparison with rolled prints) or for use in identification searches. Note, the thresholds in Table 5.8 do apply to plain captured fingerprint in enrolment scenarios where the plain fingerprints are captured for control purpose of rolled fingerprints.

Finger Position	Finger Code	NFIQ 2.0 Threshold
Right thumb	1	20
Right index finger	2	20
Right middle finger	3	20
Right ring finger	4	10
Right little finger	5	10
Left thumb	6	20
Left index finger	7	20
Left middle finger	8	20
Left ring finger	9	10

Finger Position	Finger Code	NFIQ 2.0 Threshold
Left little finger	10	10

Table 5.8. Thresholds for Plain Control /Identification Fingerprints

5.4.3.1.6. Thresholds for Rolled Fingerprints

The following thresholds as indicated in Table 5.9 apply when fingerprints are captured rolled for enrolment purposes.

Finger Position	Finger Code	NFIQ 2.0 Threshold
Right thumb	1	20
Right index finger	2	15
Right middle finger	3	15
Right ring finger	4	10
Right little finger	5	5
Left thumb	6	20
Left index finger	7	15
Left middle finger	8	15
Left ring finger	9	10
Left little finger	10	5

Table 5.9. Thresholds for Rolled Fingerprints

5.5. FM Category Presentation Attack Detection

The objective of the Function Module presentation attack detection (PAD) is to avoid presentations with the goal to subvert an enrolment, verification of identification process.

5.5.1. FM PAD-FP-APP1

This Function Module describes requirements for presentation attack detection in the context of the acquisition of fingerprint biometrics. This Function Module is especially relevant for use cases where no direct observation of the acquisition process by an operator is possible (e.g. in self-service scenarios).

5.5.1.1. Requirements

5.5.1.1.1. General Requirements

The capture system SHALL contain a presentation attack detection subsystem according to [ISO_PAD_1] detecting spoofing attempts using artefacts by which an attacker is trying to establish a different biometric characteristic as probe in the verification or identification process.

The presentation attack detection subsystem MAY consist of hardware and software (e.g. the used fingerprint scanner MAY have additional sensors designed for this purpose).

Typical artefacts consist of fake fingers (e.g. silicone, gelatine based). The presentation attack detection subsystem SHALL be able to detect all well-known attack types.

The presentation attack detection SHALL be conducted both in supervised acquisition scenarios, e.g. in a counter scenario, and in unsupervised acquisition scenarios, e.g. in self-service scenarios. Thereby, the presentation attack detection SHALL be conducted for all acquisition purposes, e.g. enrolment, identification and verification.

Neither the presentation attack detection result nor presentation attack score SHALL be displayed to the person who's fingerprints are acquired.

5.5.1.1.2. Performance

The presentation attack system's usability in the field in terms of bona fide presentation classification error rate (BPCER) and bona fide presentation non-response rate (BPNRR) as defined by [ISO_PAD_3] SHOULD be compliant with the thresholds in Table 5.10.

Usability Metric	Threshold
BPCER	< 2 %
BPNRR	< 1 %

Table 5.10. Usability Metrics Fingerprint PAD

5.5.1.1.3. Self-Service Scenarios Requirements

In self-service scenarios where the biometric subject's fingerprints SHALL be acquired by an unsupervised fingerprint scanner, the presentation attack detection result from the unsupervised acquisition SHALL be displayed to a responsible process operator.

5.5.1.1.4. Integration Requirements

The presentation attack detection subsystem SHALL be independent of the regular capture subsystem, i.e. it SHALL NOT inhibit capturing image data in case of a suspected attack. It SHALL signal its detection results in the form of a presentation attack detection for each finger individually. An overall result to the calling application SHALL also be applied additionally. The score SHALL be a normalized `double` in the range [0,...,1]. A binary score SHALL not be used (e.g. True or False, 1 or 0). It SHALL additionally provide detailed information about the scores of the presentation attack detection.

OPTIONAL, if the Function Module is used within a comparison scenario, it is allowed to only signal the detection result in conjunction with a positive matching decision to the operator.

The PAD result SHALL correspond to the chosen finger capture attempt.

5.5.1.1.5. Maintenance Requirements

As new technologies and new attack mechanisms are developed over time, the presentation attack detection subsystem SHALL be regularly updated and re-evaluated.

5.5.1.2. Recommendations

5.5.1.2.1. Certification Recommendations

To ensure comparable performance of presentation attack detection subsystems, the system SHOULD be certified under the Common Criteria Agreement according to one of following Protection Profiles:

- BSI-CC-PP-0063-2010: Fingerprint Spoof Detection Protection Profile (FSDPP)
- BSI-CC-PP-0062-2010: Fingerprint Spoof Detection Protection Profile based on Organisational Security Policies (FSDPP_OSP)

5.6. FM Category Compression

The objective of the Function Module Compression (COM) is to keep the biometric data below a feasible size without losing too much quality for a biometric verification or identification.

5.6.1. FM COM-FI-JPG

This function block describes requirements and interfaces for the compression of photos using the JPEG format for reference storage.

5.6.1.1. Requirements

The compression method for facial images SHALL be JPEG (compare [ISO_10918-1]). The compression algorithm SHALL be parametrized in order that the application specific requirements as listed in Table 5.11 are met by the resulting compressed image. Within the Compression Module multiple lossy compressions SHALL not allowed.

Minimum File Size	Recommended Compression Ratio
Small size image (531x413 pixel)	
25 KiB	20:1
Medium size image (800x600 pixel)	
35 KiB	20:1
Standard size image (1600x1200 pixel)	
100 KiB	20:1

Table 5.11. Requirements to Compression Using JPEG Format

For conformance the implementation encapsulating the compression has to provide an interface that accepts predefined test data instead of performing the regular process.

5.6.2. FM COM-FP-WSQE

This Function Module describes requirements and interfaces for the compression of fingerprint images by Wavelet Scalar Quantisation (WSQ) method.

5.6.2.1. Requirements

WSQ SHALL be used as compression method for fingerprint images. A bit rate of 0.75 SHALL be used as compression parameter. This is equivalent to a compression factor of approximately 1:15¹ (according to [ISO_FINGER]). The implementation of the used WSQ algorithm SHALL be certified by the FBI and SHALL be referenced by the respective certificate number (coded in the WSQ header). The certified WSQ implementation SHALL be version 3.1 and SHALL base on NBIS Version 5.0. Within the Function Module Compression multiple lossy compressions SHALL NOT be allowed.

¹For estimation of compression factor it is allowed to crop to the minimum size containing the fingerprint defined if a sensor is used with a larger capturing area than this minimum.

If the resulting effective compression rate C does not fulfil the requirement of Equation 5.3 for this particular case only a stronger or weaker compression C SHALL be used.

$$1 : 10 \leq C \leq 1 : 20 \quad (5.3)$$

Therefore, an iterative process SHALL be applied, which results in an image file with an effective compression rate within the defined range, refer to Equation 5.3.

The effective compression rate SHALL be calculated by Equation 5.4 where S_{wsq} is the size in bytes of the resulting WSQ file and S_{raw} is the size in bytes of the raw fingerprint image.

$$C = \frac{S_{wsq}}{S_{raw}} \quad (5.4)$$

5.7. FM Category Operation

Within the Function Module Operation (O), the working process is specified for the respective operator. All steps that have to be executed are described sequentially and in more detail. This also includes descriptions of how to proceed in error cases.

5.7.1. FM O-FI-ALL

This Function Module describes requirements to be observed by the operator who handles the facial image acquisition process. This includes the full working process.

5.7.1.1. Requirements

- If the software based quality assessment rejects the image, the operator SHALL have the option to give a veto in order to release the image despite a negative software decision and vice versa.
- The operator SHALL be responsible for an adequate cleanliness of all capture hardware components.

5.7.1.2. Recommendations

- OPTIONALLY, the operator can use the photo guideline.

5.7.2. FM O-FI-DC

This Function Module describes requirements to be observed by the operator who handles the facial image acquisition process with a digital camera.

5.7.2.1. Requirements

- The operator SHALL ensure that different environmental lighting conditions caused by direct or indirect sunlight and different seasons of the year SHALL NOT influence the proper and uniform lighting of the captured facial image.
- Direct and cross irradiation of lighting SHALL be avoided by the operator.

5.7.3. FM O-FP-ALL

This Function Module describes requirements to be observed by the operator who handles the acquisition process of fingerprint images.

5.7.3.1. Requirements

5.7.3.1.1. Operation of Devices

The following operational requirements SHALL apply:

- The operator SHALL be responsible for an adequate cleanliness of all capture hardware components. Fingerprint scanners SHALL be cleaned regularly to provide good probe images.
- The fingerprint scanner SHALL be regularly calibrated (e.g. once a day). The operator SHALL ensure that the sensor platen is clean before calibration to reduce the risk of ghost images.

5.7.3.1.2. Environmental Requirements

The following requirements for infrastructure and environment SHALL be met:

- The operator SHALL ensure that different environmental lighting conditions caused by direct or indirect sunlight and different seasons of the year SHALL NOT influence the scanner capture process.
- Direct and cross irradiation of lighting on the sensor platen SHALL be avoided completely.

5.8. FM Category User Interface

It is the task of the User Interface (UI) to display and visualise the respective information that is obtained from the underlying Function Modules.

5.8.1. FM UI-FI-OP

This Function Module describes requirements for the user interface of the software displaying the result of the quality assessment and verification of facial images to the operator.

5.8.1.1. Requirements

The following SHALL be shown to the operator for the enrolment:

- displaying of the current evaluated picture
- displaying of all criteria evaluated with the current value and threshold as well as their relation: OK/NOK for every criterion
- displaying of the summarised result OK/NOK for the current picture
- provision of the veto power for the operator
 - enforcement of OK for obvious reasons (e.g. disability)
 - enforcement of OK without obvious reasons
 - enforcement of NOK to overrule software based quality assessment

The following SHALL be shown to operator for the verification:

- Visual feedback of the verification process SHALL be provided for the operator. At least both images (live and reference) and the (boolean) result of the verification SHALL be displayed to the operator.
- In case multiple verifications of facial images are conducted, only the not successfully compared pairs of facial images SHALL be displayed to the operator.

5.8.2. FM UI-FI-BSJ

This Function Module describes requirements for the user interface of facial image acquisition shown to the biometric subject.

5.8.2.1. Recommendations

The following recommendations SHOULD be met for the user interface of biometric subject:

- An indicator showing the capture status SHOULD be displayed to the biometric subject.
- Graphics (e.g. buttons or pictograms) SHOULD use an uniform colour palette without utilizing clashing colours.

5.8.3. FM UI-FP-OP

This Function Module describes requirements for the user interface of the software displaying the result of the quality assessment of fingerprint images to the operator.

5.8.3.1. Requirements

Visual feedback of the fingerprint acquisition at least displaying of the final images SHALL be provided to the operator.

If a control verification or sequence check error occurs, the fingers involved in the unexpected successful comparisons SHALL be displayed to the operator.

In case no successful comparison occurred during the control verification, a warning SHALL be displayed to the operator, that the control verification was not successful.

The segmented single fingerprints SHALL be visualised to the operator to identify potential failures in segmentation. This can be realised by displaying the result containing up to ten segmented single fingerprints.

In case the amount of captured fingerprints mismatches with the amount of expected fingers a warning SHALL be displayed to the operator.

5.8.3.2. Recommendations

The indication of the quality level SHOULD be displayed to the operator.

A live view of the fingerprint scanner SHOULD be displayed to the operator during the fingerprint acquisition. This also includes live information, e.g. about the correct positioning of fingers on the fingerprint scanner that supports the operator guiding the biometric subject.

5.8.4. FM UI-FP-BSJ

This Function Module describes requirements for the user interface of the biometric subject for fingerprint acquisitions.

5.8.4.1. Recommendations

The following recommendations SHOULD be met for the user interface:

- An indicator showing the capture status SHOULD be displayed to the biometric subject.
- An indication when the capture process has finished SHOULD be displayed.
- Graphics (e.g. buttons or pictograms) SHOULD use an uniform colour palette without utilizing clashing colours.

- The acquisition process SHOULD be displayed as real time feedback to the biometric subject (e.g. with the help of a feedback monitor).
- A visualization which fingerprint / hand to place on the sensor SHOULD be given.

5.9. FM Category Reference Storage

The objective of the Function Module Reference Storage (REF) is to store biometric data in a way that it can be used for reference purposes later on.

5.9.1. FM REF-FP-AAD

This Function Module describes requirements how fingerprint images are stored as reference data within the context of the Application Arrival Document.

5.9.1.1. Requirements

The captured fingerprints of an applicant SHALL be stored in the CIR and made available immediately for further identification requests.

5.9.2. FM REF-FI-AAD

This Function Module describes requirements how facial images are stored as reference data in the context of the Application Arrival Document.

5.9.2.1. Requirements

The facial image of an applicant SHALL be stored in the CIR and made available immediately for further identification requests.

5.10. FM Category Biometric Comparison

The Function Module Biometric Comparison (CMP) encloses the mechanisms and algorithms to verify or identify an identity based on a 1:1 or 1:many biometric comparison between reference data and a current biometric sample (usually a live presented image) regardless of where the reference is stored (e.g. passport, identity card, Automated Biometric Identification System (ABIS), database, ...).

5.10.1. FM CMP-FP-CC

This Function Module contains requirements for the cross-comparison in order to match plain and rolled captured fingerprints.

5.10.1.1. Requirements

A fingerprint verification algorithm SHALL be used for cross-comparison of the plain and rolled captured fingerprints intended for enrolment.

The used verification algorithm SHALL be configured at a security level (threshold) guaranteeing a maximum false-match-rate (FMR) of at least 0,1 % (1/1000) at a false non-match rate (false-non-match-rate (FNMR)) below 2 %. It SHALL be allowed to configure a threshold which allows stronger settings (lower FMRand/or FNMR).

Furthermore, the overall system SHALL be calibrated for the security level set within this specific scenario of verification. The vendor of the verification algorithm SHALL provide calibration data based on the actual system performance.

Input data of the verification are the segmented plain and rolled captured fingerprints from the applicant. Output of the algorithm SHALL be a comparison score for both prints of each captured finger and the result of the verification depending on the configured threshold of the algorithm.

5.11. FM Category Logging

The Function Module Logging (LOG) contains logging requirements.

5.11.1. FM LOG-ALL-GENERIC

The Function Module Logging contains requirements as to which data has to be logged for a specific application.

5.11.1.1. Requirements

A transaction SHALL cover all information concerning one single biometric subject. During the biometric process the following data SHALL be gathered / created by the application:

- generic process information:
 - a globally unique Transaction ID conforming to [RFC4122] Version 1 UUID specification
 - global start time of the transaction (timestamp of the beginning of the biometric process as defined by the application profile²)
 - global end time of the transaction (timestamp of the end of the biometric process as defined by the application profile)
 - fully qualified host name (or if not available any other locally unique identifier serving as host name) of the station
 - type of station (e.g. stationary/mobile)
 - location of station (The exact semantic of this value is profile-dependent. See the specific profile in for a refined definition.)
 - the software used in this transaction (biometric component), at least with the following identifiers
 - vendor name
 - software name
 - version number (Using a version numbering scheme which allows for proper lexicographic ordering is highly recommended)
 - optional configuration information
 - error code (optional) detailing any abnormal termination of the process
 - a transaction reference if this transaction is dependent or derived from another transaction
- information about any identification processes performed during this transaction:
 - start time of the identification process (i.e. beginning of capturing biometric data)
 - submit time of the identification process (i.e. when the captured data is submitted to the backend system for identification)
 - end time of the identification process (i.e. when the results from the backend system are available or the process terminated with a timeout)
 - a list of modalities used for identification
 - the result of the identification
 - the count of candidates available

²For example this may be the moment in time when the operator has started the process by clicking on "start acquisition".

- for each candidate:
 - the rank of the candidate
 - score and threshold information
- an error code in case of abnormal termination of the identification process
- information about any enrolment processes performed during this transaction:
 - start time of the enrolment process (i.e. beginning of capturing biometric data)
 - optional submit time of the enrolment process (i.e. when the captured data is submitted to the backend for identification). This element SHALL be present in cases where the central system replies directly with enrolment status information.
 - end time of the enrolment process (e.g. when the process terminated with a timeout)
 - a list of modalities used for enrolment
 - the enrolment status (i.e. whether the subject was enrolled successfully)
 - an error code in case of abnormal termination of the enrolment process
- information about any control verifications performed during enrolment:
 - information about any verification processes performed during this transaction
 - start time of the verification process (i.e. beginning of capturing biometric data)
 - end time of the verification process
 - information about the references used for this verification processes (image type, position codes)
 - the verification result
 - for each verification:
 - the verification result
 - for each comparison:
 - the result of the comparison
 - the duration of the comparison process
 - detailed scoring and threshold information
 - an error code in case of abnormal termination of the comparison process
 - an error code in case of abnormal termination of the verification process
- information about the records collected in this transaction:
 - type of record (encoding format)
 - size of record
 - purpose of the record (enrolment, identification, verification)

The vendor SHALL provide a detailed list of error codes used with complete semantic descriptions.

5.11.2. FM LOG-ALL-AAD

This Function Module describes additional requirements and interfaces for the logging of process information for the application Arrival Attestation Document.

5.11.2.1. Requirements

The following additional data SHALL be gathered during the biometric process:

- Information about any existing facial images of the applicant in the CIR
 - number of images
 - whether an acceptable image is available and
 - whether any of the acceptable images was used.
- Issuance status of Arrival Attestation Document (i.e. document issued vs. issuance postponed)
- Information whether fingerprints are legally allowed to be captured

5.11.3. FM LOG-FP-GENERIC

This Function Module describes requirements and interfaces for the logging of information regarding fingerprint images for all profiles.

5.11.3.1. Requirements

Within a transaction for each set of fingerprints used for enrolment / verification / identification, the following data items SHALL be collected:

- the purpose of the acquisition (enrolment, identification, verification)
- start time of the fingerprint acquisition process
- end time of the fingerprint acquisition process
- software components used in this fingerprint acquisition process
- hardware components used in this fingerprint acquisition process
- the finger capture mode (flat, rolled, contactless)
- information about missing fingers (in relation to the requirement of the profile)
- information for each capture process for a dedicated fingerprint of slap, detailing:
 - fingerprint or slap code
 - duration of the capture
 - information whether this capture satisfies the quality requirements of the profile
 - count of single capture attempts performed for this fingerprint of slap
 - the capture number of the selected fingerprint or slap in case of multiple acquisitions
 - results from the control verification process for each finger (e.g. when comparing a rolled image against a finger extracted from a control slap)
 - for each capture attempt, detailing:
 - whether this was an acceptable capture attempt (from the application software perspective, independent of the quality assessment)
 - the duration of the capture attempt
 - in case of an unacceptable capture attempt:
 - the reason for rejection this capture attempt
 - an error code detailing the reason of rejection
- For the best capture attempt, detailed quality information about the result SHALL be logged. For all other capture attempts detailed quality information, if calculated during the process, SHOULD be logged:
 - information about the quality assessment software
 - duration of quality assessment
 - detailed quality values in the range 0-100
 - fingerprint or slap code
 - any error code in case of abnormal termination of the quality assessment
- uniqueness check information, detailing:
 - information about the uniqueness check algorithm
 - the configured security level
 - information about potential duplicates including finger codes and detailed scoring information
 - any error code in case of abnormal termination of the uniqueness check
- information about PAD data during the capture:
 - information about the PAD subsystem
 - the overall PAD assessment result
 - for each probe:
 - the PAD result
 - detailed PAD quality values accompanied by
 - identifiers
 - upper and lower value bounds

- upper and lower threshold bounds
- an error code in case of abnormal termination of the fingerprint acquisition process.
- information about the user interface:
 - an indication of a displayed PAD alert if PAD was performed during the acquisition process, the PAD result was at least once detected and displayed to the operator during the acquisition process
 - an indication that a live feedback screen was available to the biometric subject if alive feedback screen was available to the biometric subject

The vendor SHALL provide a detailed list of error codes used with complete semantic descriptions.

Within a transaction for each capture attempt acquired for enrolment / verification / identification, detailed information about the quality, if calculated during the process, SHOULD be logged:

- information about the quality assessment software
- duration of quality assessment
- detailed quality values in the range 0-100
- fingerprint or slap code
- any error code in case of abnormal termination of the quality assessment

5.11.4. FM LOG-FI-GENERIC

This Function Module describes requirements and interfaces for the logging of information regarding facial images for all profiles.

5.11.4.1. Requirements

Within a transaction for each facial image used for enrolment / verification / identification, the following data items SHALL be collected:

- the purpose of the acquisition (enrolment, identification, verification)
- start time of the facial acquisition process
- end time of the facial acquisition process
- software used in this facial acquisition process
- hardware used in this facial acquisition process
- the source of the facial image under consideration
- the count of face captures performed
- for each face capture if a veto was put by the operator: the type of veto (OK/NOK)
- for the selected capture, detailed quality information about the result, detailing:
 - information about the quality assessment software
 - duration of quality assessment
 - detailed quality values accompanied by:
 - identifiers
 - upper and lower value bounds
 - upper and lower threshold bounds
 - any error code in case of abnormal termination of the quality assessment
- information about PAD data during the capture:
 - information about the PAD subsystem
 - the overall PAD assessment result
 - for each probe:
 - the PAD result
 - detailed PAD quality values accompanied by

- identifiers
- upper and lower value bounds
- upper and lower threshold bounds
- information about the user interface:
 - an indication of a displayed PAD alert if PAD was performed during the acquisition process, the PAD result was at least once detected and displayed to the operator during the acquisition process
 - an indication that a live feedback screen was available to the biometric subject if a live feedback screen was available to the biometric subject
- an error code in case of abnormal termination of the facial acquisition process

The vendor SHALL provide a detailed list of error codes used with complete semantic descriptions.

5.12. FM Category Coding

This Function Module Coding (COD) contains the procedures to encode quality data as well as biometric data in defined formats. Interoperability is provided by means of standard compliant coding.

5.12.1. FM COD-ALL-AAD

This Function Module describes requirements and interfaces for the overall coding of biometric and biographic data used within the context of the Arrival Attestation Document.

5.12.1.1. Requirements on Biometric and Biographic Data Encoding for the Central Foreigners Register

Biographic data and the facial image are delivered to the Central Foreigners Register in the compressed format as defined by Section 5.6 with further encoding.

5.12.1.2. Requirements on Biometric and Biographic Data Encoding in GSAT 3

In general the XML-based standard [GSAT3] does apply for coding of both biometric and biographic data of an applicant and process related data. Depending on the biometric modality, the corresponding coding Function Module and the declared mandatory data fields SHALL be considered. The version 3.02 of the GSAT SHALL be used.

5.12.1.3. Requirements on Encoding Logging Data

The logging data as defined by the Section 5.11 SHALL be encoded as XML according to the schema definition as `aad-app` element. The XML encoding is defined by the XML schema definition in the file „aad4v3.xsd“ and referenced schema files.

All log data SHALL be encoded as far as it is available throughout the acquisition process (e.g. fingerprint quality data is encoded if and only if fingerprint capture was performed).

The GSAT transaction container SHALL be embedded in the XML log (`XMLRecord` element) for conformance testing of the encoding.

5.12.2. FM COD-FP-GSAT3

This function block describes requirements and interfaces for the coding of fingerprint images according to the German Standard for Automated Fingerprint Identification System (AFIS) transactions in XML format.

5.12.2.1. Requirements on Encoding

For data format and encoding, the XML-based standard [GSAT3] SHALL apply. The version 3.02 of the GSAT SHALL be used.

5.12.3. FM COD-FI-GSAT3

This function block describes requirements and interfaces for the coding of facial images according to the German Standard for AFIS transactions in XML format.

5.12.3.1. Requirements on Encoding

For data format and encoding, the XML-based standard [GSAT3] SHALL apply. The version 3.02 of the GSAT SHALL be used.

5.13. FM Category Evaluation

This Function Module Evaluation contains methods and interfaces which are used in the scope of evaluation based on the specified log data of this Technical Guideline.

5.13.1. FM EVA-ALL-GENERIC

This Function Module defines general requirements for evaluations realized by plots, graphics and tables.

5.13.1.1. Requirements

The general requirements for plots, graphics, tables etc. defined in this module SHALL apply for all evaluations if not overruled by evaluation specific requirements.

5.13.1.2. Representation of Component Information

If an evaluation specification requires to use information of an XML-element of type `type.component`, e.g. for a software or hardware, a string concatenation of its child elements Vendor, Name, Version and Firmware-Version SHALL be used to represent the XML-element of type `type.component`. If a child element is empty, this child element SHALL be excluded from the string representation.

If the child element `ConfigurationInformation` is used for the application, the configuration information SHALL be added to the string representation if reasonable for the specific evaluation e.g. if the configuration parameter may influence the aspects addressed by the specific evaluation.

The elements of the string representation SHALL be separated by “,”.

5.13.1.3. Number and Date Formatting

The following applies for all numbers in plots, graphics and tables:

- The “.” or a blank SHALL be used as thousands separator.
- The “,” SHALL be used as decimal separator.
- Small numerics, i.e. smaller than 10^{-4} , SHOULD be denoted in scientific notation e.g. $5,34 \cdot 10^{-7}$.
- Large numerics, i.e. bigger than 106, SHOULD be denoted in scientific notation or by reasonable abbreviations e.g. “M” for million.
- Decimal fractions SHOULD be rounded to not more than two digits.
- Relative frequencies SHALL be noted as decimal.

The following applies for all numbers in tables:

- Leading zeros in the table body’s cells SHOULD be omitted for decimal fractions e.g. “.34” instead of “0,34”.

The following applies for all dates in plots, graphics and tables:

- The order of date components SHALL be (year, month, day). Note, that not all components are required.
- Day, month and year components SHALL be numeric.
- The “.” SHALL be used as separator between numeric components.
- Leading zeros SHALL be used to fill up numeric months and days to two digits.
- Years SHALL be presented by four digits.

5.13.1.4. Use of Colours

The following requirements apply for colours used in plots and graphics:

- The used colours SHALL be consistent over all plots and graphics generated. Colours SHALL be consistent over variable types, i.e. the same colour schema SHALL be used for the same variable type in different plots and graphics.
- Colours commonly connoted with specific attributes SHALL be used only in coherence to the coloured object’s meaning e.g. a plot or graphic object indicating an error fraction shall not be coloured green.
- If no need to use more than one colour in a plot or graphic, e.g. to distinguish different types of plot elements by colour or to emphasis the denotation of an element by colour, the default colour SHOULD be black.

If more than one colour is used in a plot, a meaningful legend SHALL explain the applied colour schema.

Two RECOMMENDED colour palettes for e.g. line colours or stacked bar plot partitions are given in Table 5.12.

Palette 1 Hex Colour Codes	Palette 2 RGB Colour Codes
#3E647D	255, 200, 25
#7B92A8	242, 133, 2
#82C0E9	196, 0, 70
#2D6D66	137, 13, 72
#BFA19C	0, 184, 242
#008BBC	7, 120, 165
#97B6B0	0, 79, 128
#D7D29E	116, 185, 23
#1A476F	35, 97, 78
#90353B	107, 117, 129
#9C8847	
#938DD2	
#6E8E84	
#C10534	
#CAC27E	

Table 5.12. Recommended Colour Palettes

5.13.1.5. Definitions of Terms

The term "Geographic Region" SHALL be defined according to [UN REGIO].

5.13.1.6. Trimmed Values

For trimming of values the following applies:

- Trimming of values SHALL only be allowed for input variables of plots and graphics to e.g. remove outliers.
- Trimming of values SHALL not be allowed for any kind of variables in table presentation, especially in lookup tables.
- In case plot input variables have been trimmed, the trimming method and parameters as well as the number of excluded observation SHALL be denoted as remark at the resulting plot or graphic.
- Trimming in context of this document refers to omitting the visualisation of the trimmed data e.g. for a box plot, the median and quartiles of the box SHALL still be calculated based on the total data but not on the trimmed data. However, the trimmed data points SHALL not be depicted in the box plot as outliers.

5.13.1.7. Plots, Graphics and Table in General

The following applies for all plots, graphics and tables:

- An explanatory description for each plot, graphic and table SHALL be given within a generated report.
- Every plot, graphic or table SHALL have a meaningful caption or heading.
- If finger codes are used, they SHALL be explained at the plot, graphic or table e.g. by a label or footnote.
- The units of axis, cell values and other metrics SHALL be denoted either at each value or annotated as e.g. footnote or label of axis, rows, columns.

5.13.1.8. Plots and Graphics in General

The following applies for all plots and graphics:

- Every axis of a plot or graphic SHALL have a meaningful labelling.
- If not specifically defined by the plot definition, plot axis and their labels SHALL be scaled and chosen meaningful.
- Every plot with multiple colours or other means of coding to distinguish elements SHALL have a meaningful legend explaining the coding.
- If an axis range is defined on an interval, e.g. [0,1] or [0,100], the respective axis SHALL be scaled for the full interval e.g. quality scores (0 to 100) or relative frequencies (0 to 1).

5.13.1.9. Plots and Graphic Types

The following plot and graphic types MAY be used by evaluation modules. The subsequent general plot and graphic requirement applies if not otherwise specified by the specific evaluation.

5.13.1.9.1. Pie Charts

It is RECOMMENDED to use stacked bar plots instead of pie charts.

5.13.1.9.2. Heat Map

A heat map depicts the values of a matrix by colours. Thereby, the following applies:

The matrix cell values SHALL be mapped to a colour via two steps. Step 1 SHALL map every cell value to a value in the range [0,1]. Step 2 SHALL map every value within the range [0,1] to a heat colour. The exact computation SHALL be conducted in the following way:

- Step 0
 - If negative cell values are given in the relevant matrix, Step 0 SHALL be executed before the other Step 1 and 2.
 - Step 0 SHALL subtract from every cell value the minimum value of the column (case 1), the row (case 2) or of the whole matrix (case 3). In this way all values are mapped to non-negative numbers. Then all the other computations SHALL build on the non-negative cell values.
- Step 1
 - The matrix SHALL depict the values of the cells relatively to a given maximum value. Three types of modalities are possible: The cell values colours can orientate on
 - the maximum value in their column (case 1) or
 - the maximum value in their row (case 2) or
 - the maximum value of the entire matrix (case 3).
 - Which of the possible cases SHALL be considered is defined in the specifications of this Technical Guideline for the respective heat map by the "Colour" attribute. It SHALL be visible to the viewer of heat map if the maximum of the columns, the rows or the entire table is considered. This can be done by a legend to the plot or a footnote.
 - Every cell value SHALL be divided by ...
 - the maximal value of the column (case 1)
 - the maximal value of the row (case 2)
 - the maximal value of the hole matrix (case 3)
 - In this way every cell SHALL be mapped to a value in the range [0,1]. Every maximal value SHALL be mapped to the value 1. Please note that this computation SHALL only be used to compute the heat map colour and SHALL not be used to label the cells itself (except for the case that it is the same value).
- Step 2
 - The values derived in Step 1 SHALL be mapped to a colour following the mapping defined in Table 5.13. Every maximal value of the column (case 1), of the row (case 2) or of the entire matrix (case 3) SHALL be coloured in #FF0000. Note, multiple maxima MAY be possible.

ID	Value Interval	Corresponding Colour of the Heat Map Cell
1	[0, 0.05]	#FFFFE6
2	(0.05, 0.1]	#FFFFB3
3	(0.1, 0.15]	#FFFF80
4	(0.15, 0.2]	#FFFF4D
5	(0.2, 0.25]	#FFFF19
6	(0.25, 0.3]	#FFFF00
7	(0.3, 0.35]	#FFED00
8	(0.35, 0.4]	#FFDB00
9	(0.4, 0.45]	#FFC800
10	(0.45, 0.5]	#FFB600
11	(0.5, 0.55]	#FFA400
12	(0.55, 0.6]	#FF9200
13	(0.6, 0.65]	#FF8000
14	(0.65, 0.7]	#FF6D00

ID	Value Interval	Corresponding Colour of the Heat Map Cell
15	(0.7, 0.75]	#FF5B00
16	(0.75, 0.8]	#FF4900
17	(0.8, 0.85]	#FF3700
18	(0.85, 0.9]	#FF2400
19	(0.9, 0.95]	#FF1200
20	(0.95, 1]	#FF0000

Table 5.13. Heat Map Colours

An exemplary heat map is depicted in Figure 5.1. In this example the colours of the cells are derived relatively to the maximum value of the matrix (case 3) which occurs in the fourth row and the fourth column of the matrix.

Var2	Var1						
	val1	val2	val3	val4	val5	val6	val7
val1							
val2							
val3							
val4							
val5							
val6							
val7							

Figure 5.1. Example Heat Map

5.13.1.9.3. Box Plot

A box plot depicts distributions by central distribution metrics. Thereby, the following applies:

- The lower whisker SHALL be at maximum within a 1.5 inter quartile range from the lowest quartile and the higher whisker shall be within a 1.5 inter quartile range from the highest quartile.
- Outliers SHOULD be depicted as black filled dots with 33% transparency.

An exemplary box plot is depicted in Figure 5.2.

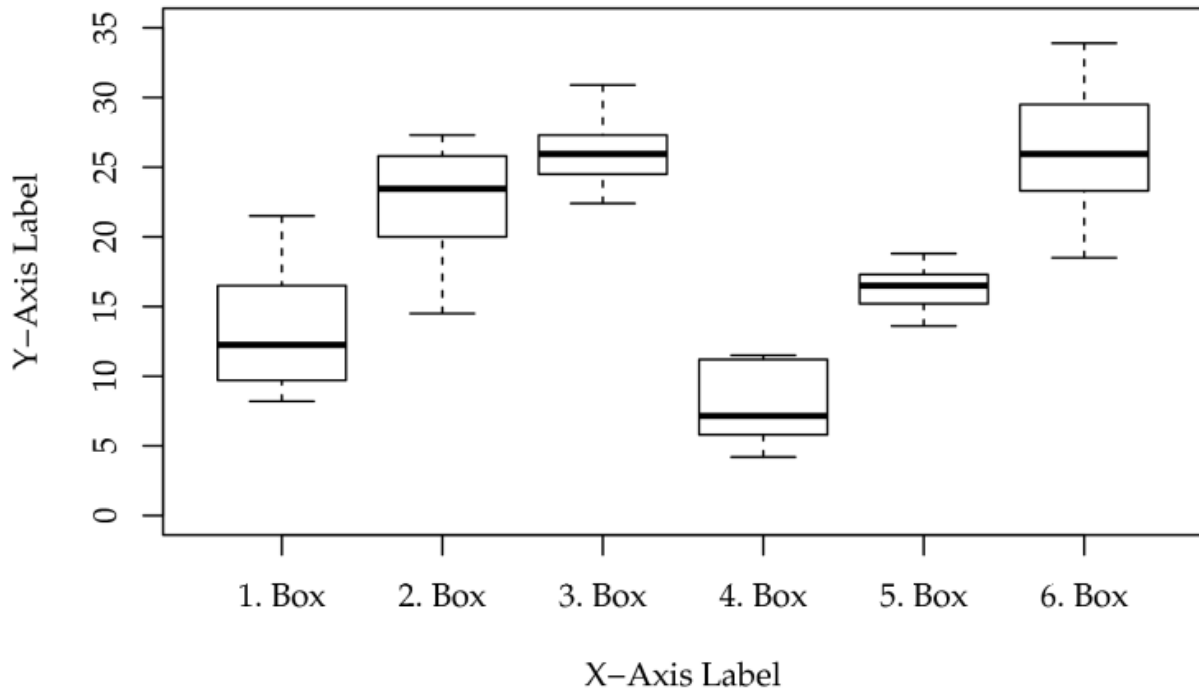

Figure 5.2. Example Box Plot

5.13.1.9.4. Scatter Plot

A scatter plot depicts two dimensional data points on an X- and Y-axis. Thereby, the following applies:

- Data points SHALL be depicted as filled dots with 33% transparency.

An exemplary scatter plot is depicted in Figure 5.3.

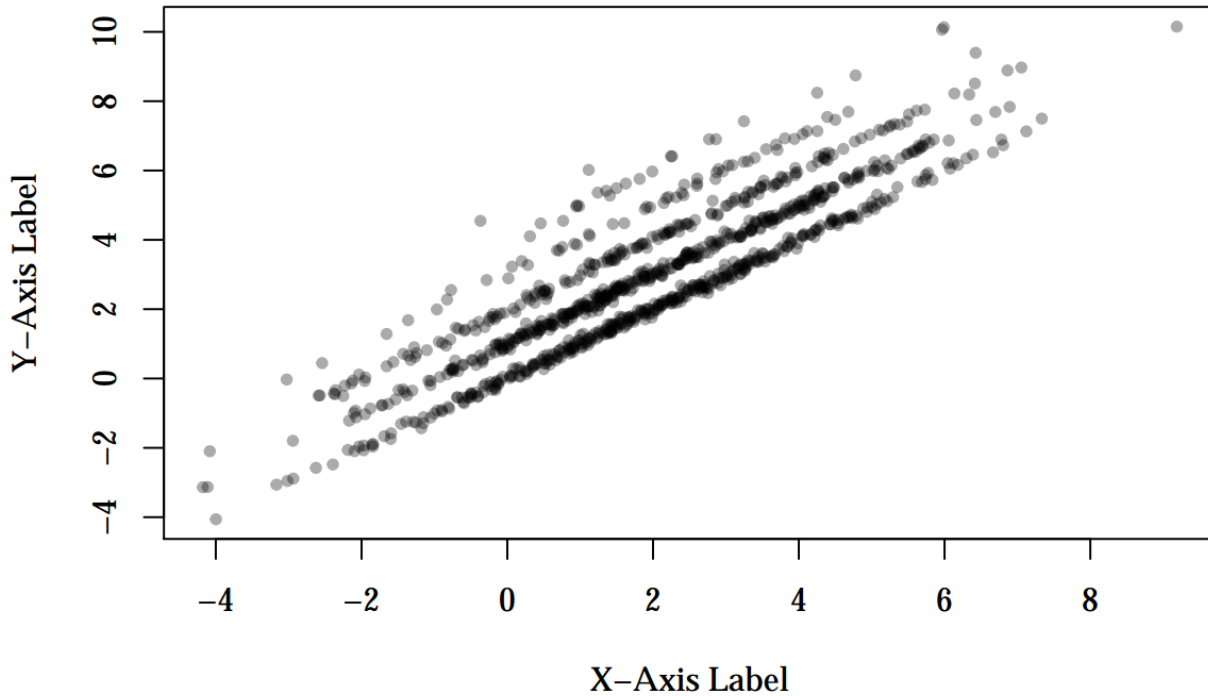

Figure 5.3. Example Scatter Plot

5.13.1.9.5. Line Plot

A line plot depicts two dimensional data points on an X- and Y-axis. Thereby, the following applies:

- Data points SHALL be connected by straight lines.
- Data points SHALL be visible i.e. not only the line shall be depicted.

An exemplary line plot is depicted in Figure 5.4.

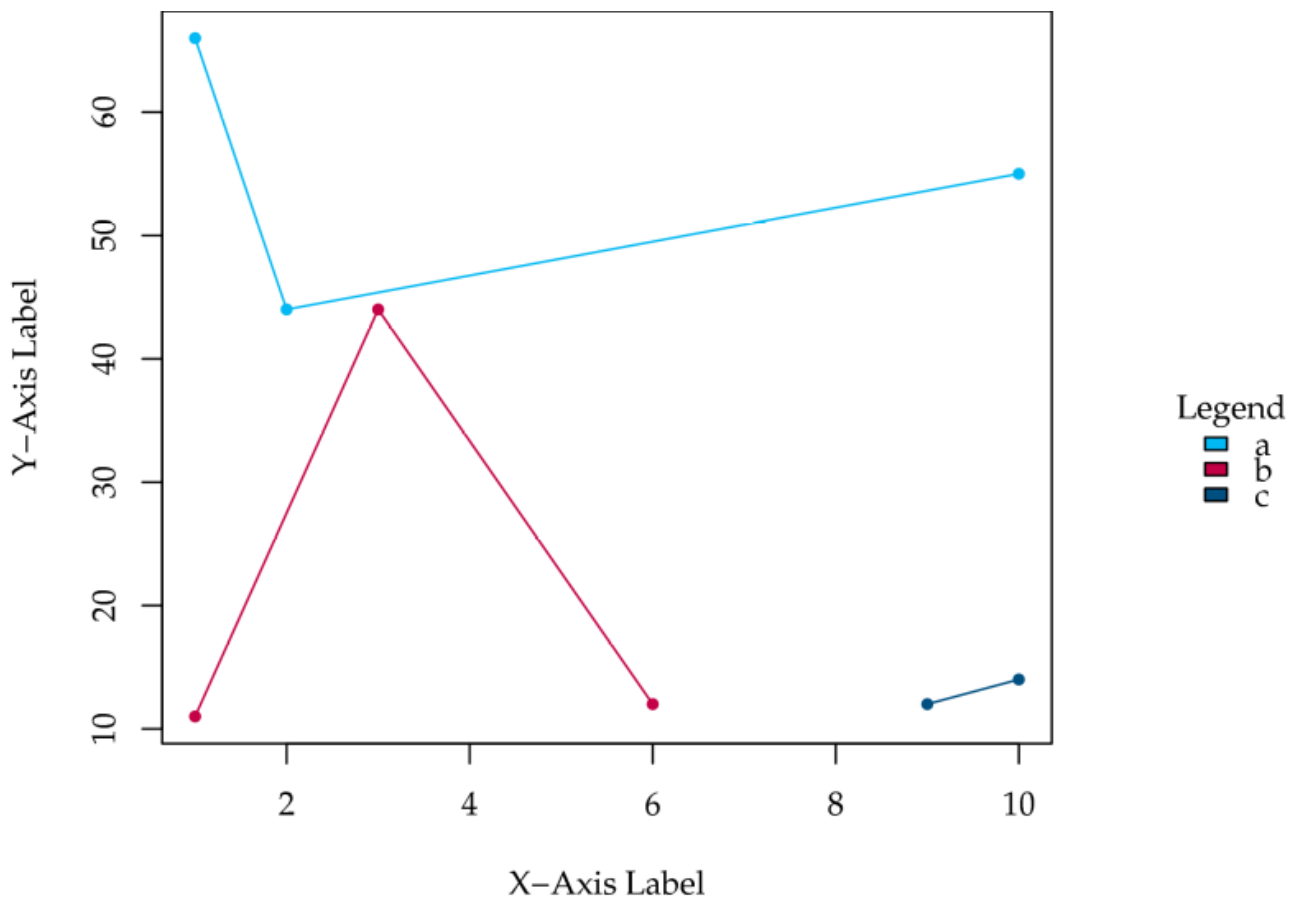

Figure 5.4. Example Line Plot

5.13.1.9.6. Histogram

A histogram is composed of vertical columns plotted on a graph for which the following applies:

- Histograms SHALL be based on continuous variables.
- It is RECOMMENDED that there is no space between adjacent columns.
- The X-axis labels SHALL be single values or a range of value descriptions, i.e. bin names.
- The height of each individual column SHALL indicate the size of the group defined by the column bin.
- The Y-axis SHALL be located at the left hand side of the histogram.
- The median of the input variable SHALL be indicated by a red solid vertical line.
- The mean of the input variable SHALL be indicated by a red dashed vertical line.
- If the number of bins is not defined by the evaluation, the number of bins SHOULD be calculated by Scott's formula, refer to Equation 5.5, or Sturges' formula, refer to Equation 5.6. Whereby k denotes the number of bins, σ the standard deviation of the input data and n the number of data points.
- If the data is of type integer the number of bins k SHALL not be greater than the range of the data plus one e.g. the minimum data point is -5 and the maximum data point is 64, the number of bins SHALL not be greater than 70.

$$\frac{3,49 * \sigma}{\sqrt[3]{n}} \quad (5.5)$$

$$k = 1 + \log_2 * n \quad (5.6)$$

An exemplary histogram is depicted in Figure 5.5.

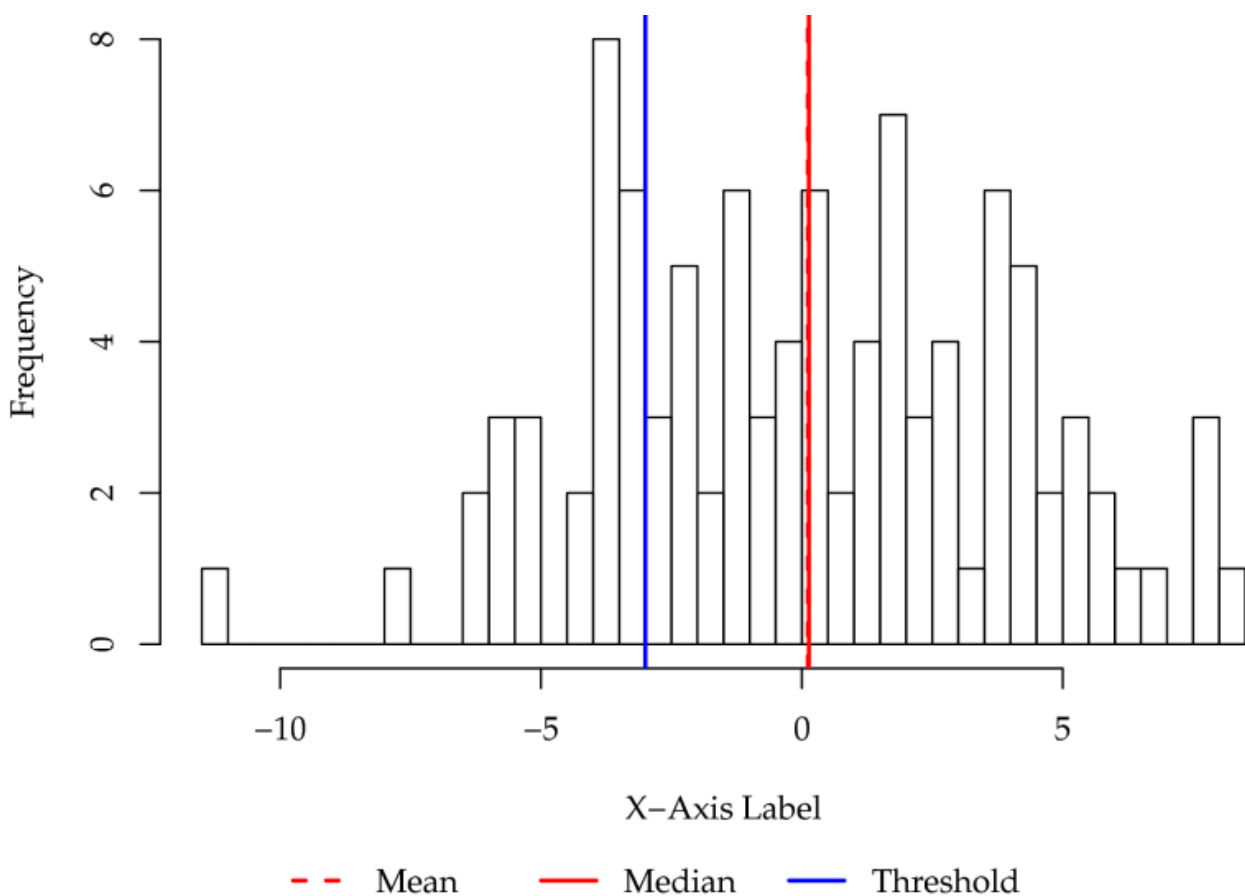

Figure 5.5. Example Histogram Plot

5.13.1.9.7. Histogram with Empirical Cumulative Distribution Function

A histogram with empirical cumulative distribution function is a histogram with an empirical Cumulative Distribution Function (CDF) added to the base histogram plot. All requirements for histograms apply. In addition, the following applies:

- The CDF SHALL be plotted as step function.
- No additional X-axis for the CDF shall be added to the base histogram.
- An additional Y-axis for the CDF shall be added to the base histogram on the right hand side, the histogram Y-axis shall be on the left hand side.
- The CDF Y-axis shall be scaled from 0 to 1 by 0.1 steps.

It is recommended to colour the CDF and its Y-axis in red.

An exemplary histogram with empirical CDF is depicted in Figure 5.6.

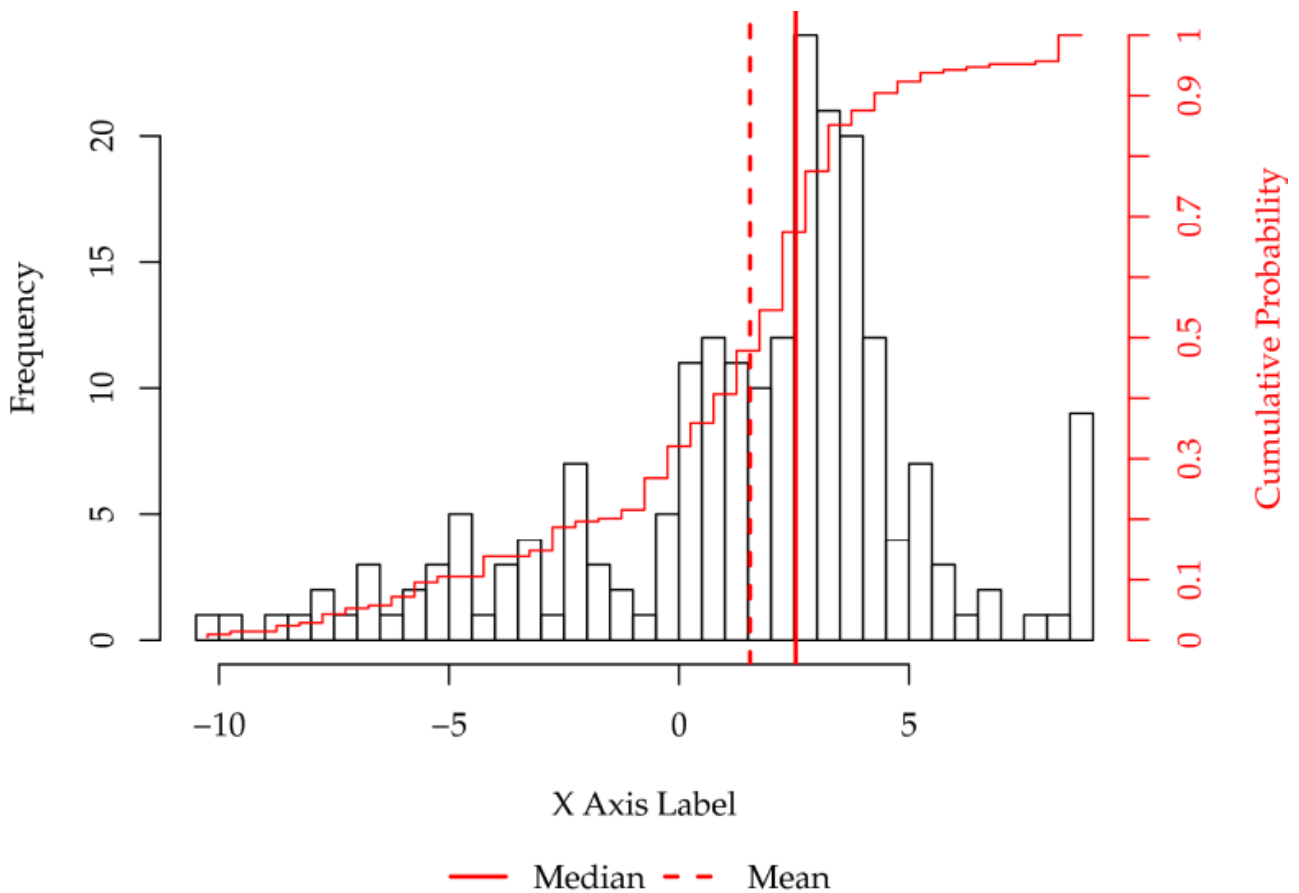

Figure 5.6. Example Histogram with Empirical Cumulative Distribution Function

5.13.1.10. Bar Plot

A bar plot is composed of vertical or horizontal bars plotted on a graph for which the following applies:

- The bars SHALL be labelled.
- A bar label SHALL represent a categorical variable.
- The height of a bar SHALL indicate the size of the group defined by the bar label.

An exemplary bar plot is depicted in Figure 5.7.

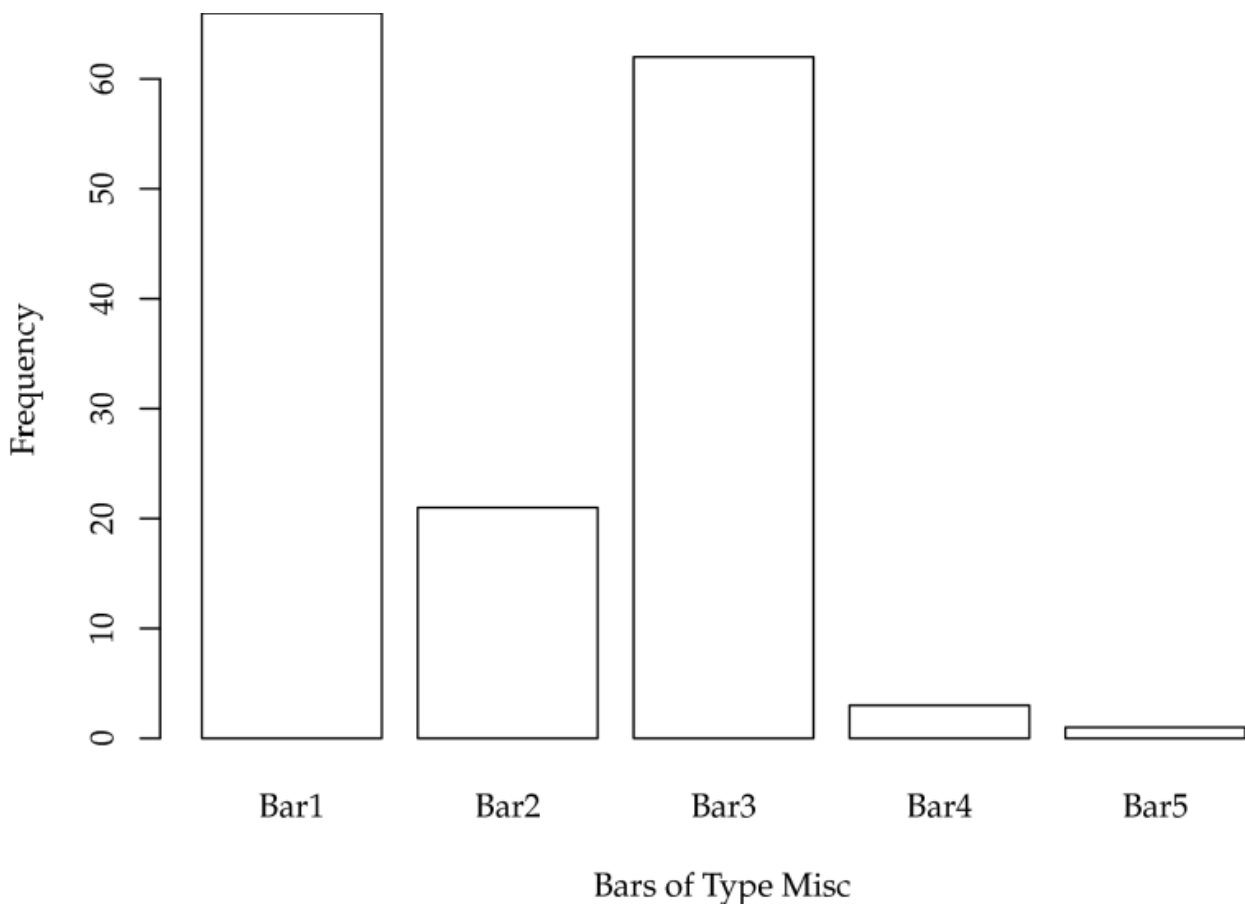

Figure 5.7. Example Bar Plot

5.13.1.11. Stacked Bar Plot

A stacked bar plot is a bar plot whose columns are partitioned by the relative frequencies of a variable. The following applies for stacked bar plots:

- Partitions SHALL be separated by different colours.
- If multiple bars are present, the order of partitions SHALL be consistent across all bars.

It is RECOMMENDED to add an axis for both, relative frequencies and absolute frequencies.

An example horizontal stacked bar plot is depicted in Figure 5.8, an example vertical stacked bar plot is depicted in Figure 5.9.

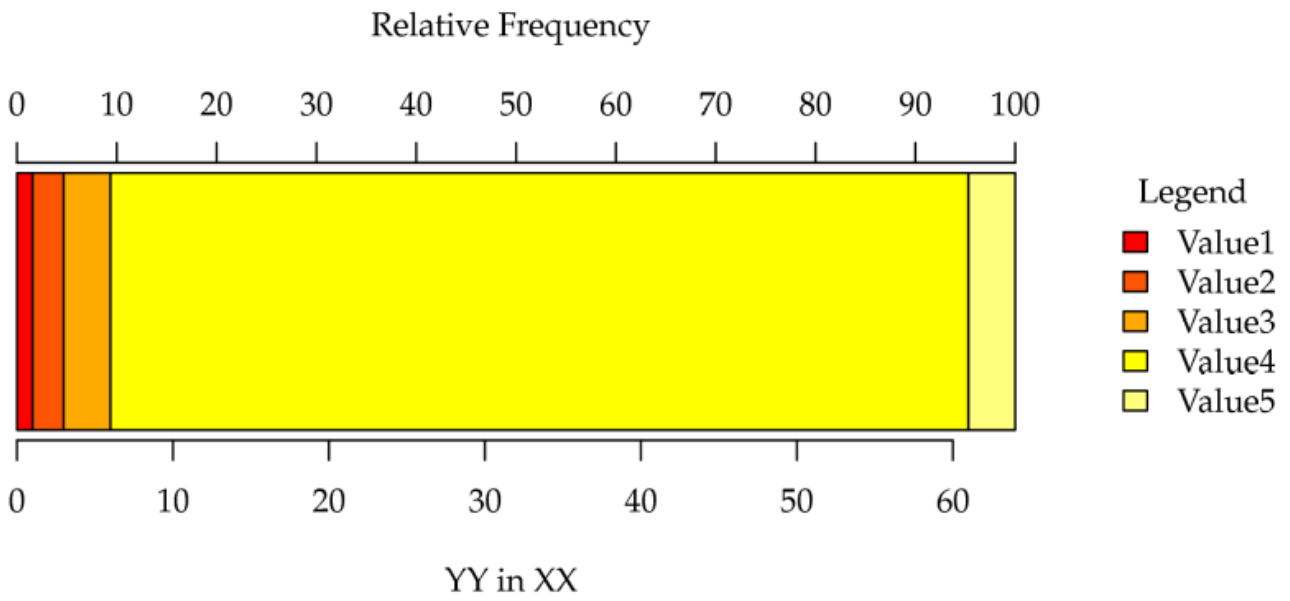

Figure 5.8. Example Horizontal Stacked Bar Plot

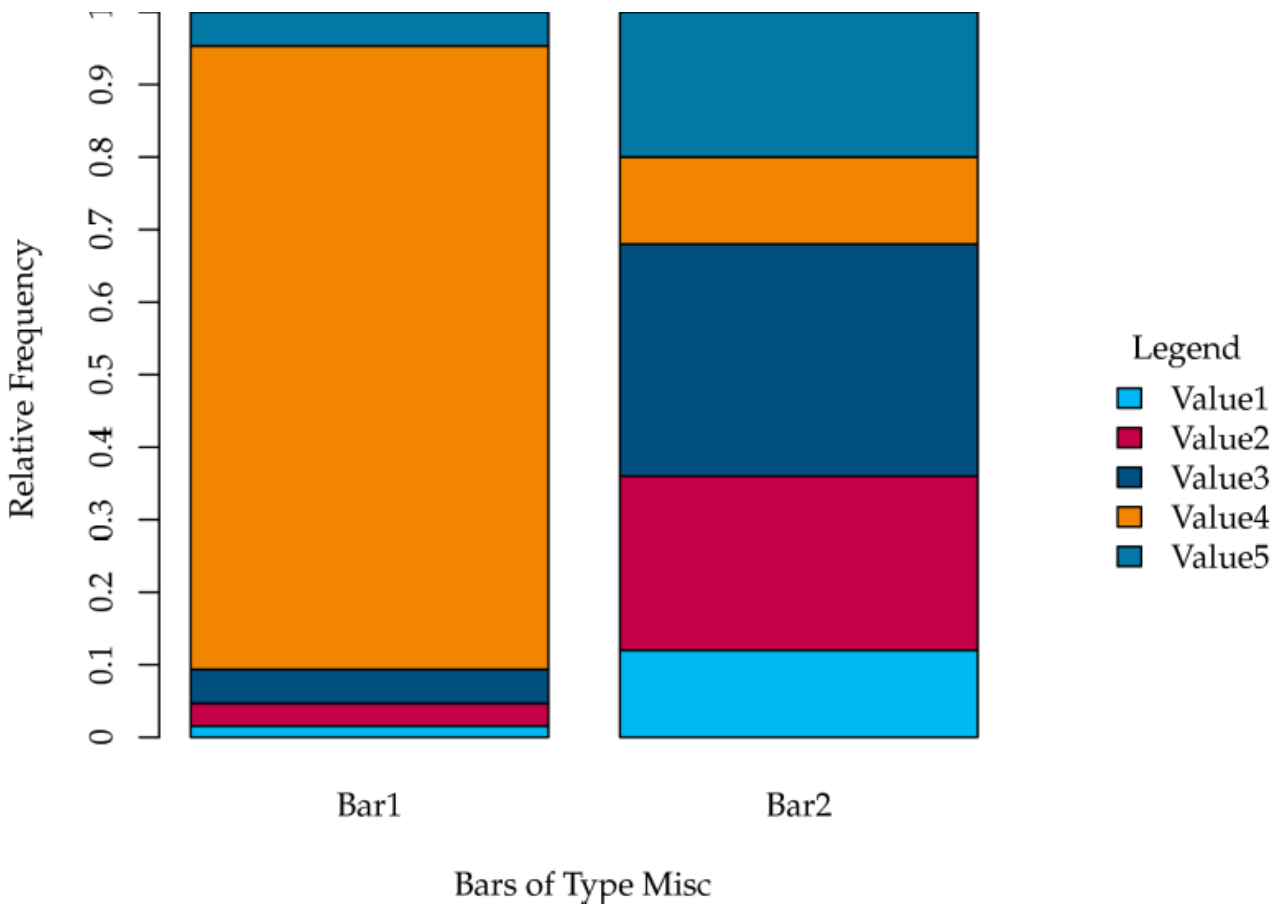

Figure 5.9. Example Vertical Stacked Bar Plot

5.13.1.12. Grouped Bar Plot

A grouped bar plot displays two variables on the X-axis by grouping the bars for the instances of one variable for every instance of the other variable. It is comparable to a stacked bar plot, where the sub-bars are not stacked but grouped next to each other. The following applies for grouped bar plots:

- Bars within a group SHALL be separated by different colours.
- If multiple bar-groups are present, the order of partitions SHALL be consistent across all groups.

An example for a grouped bar plot is displayed in Figure 5.10.

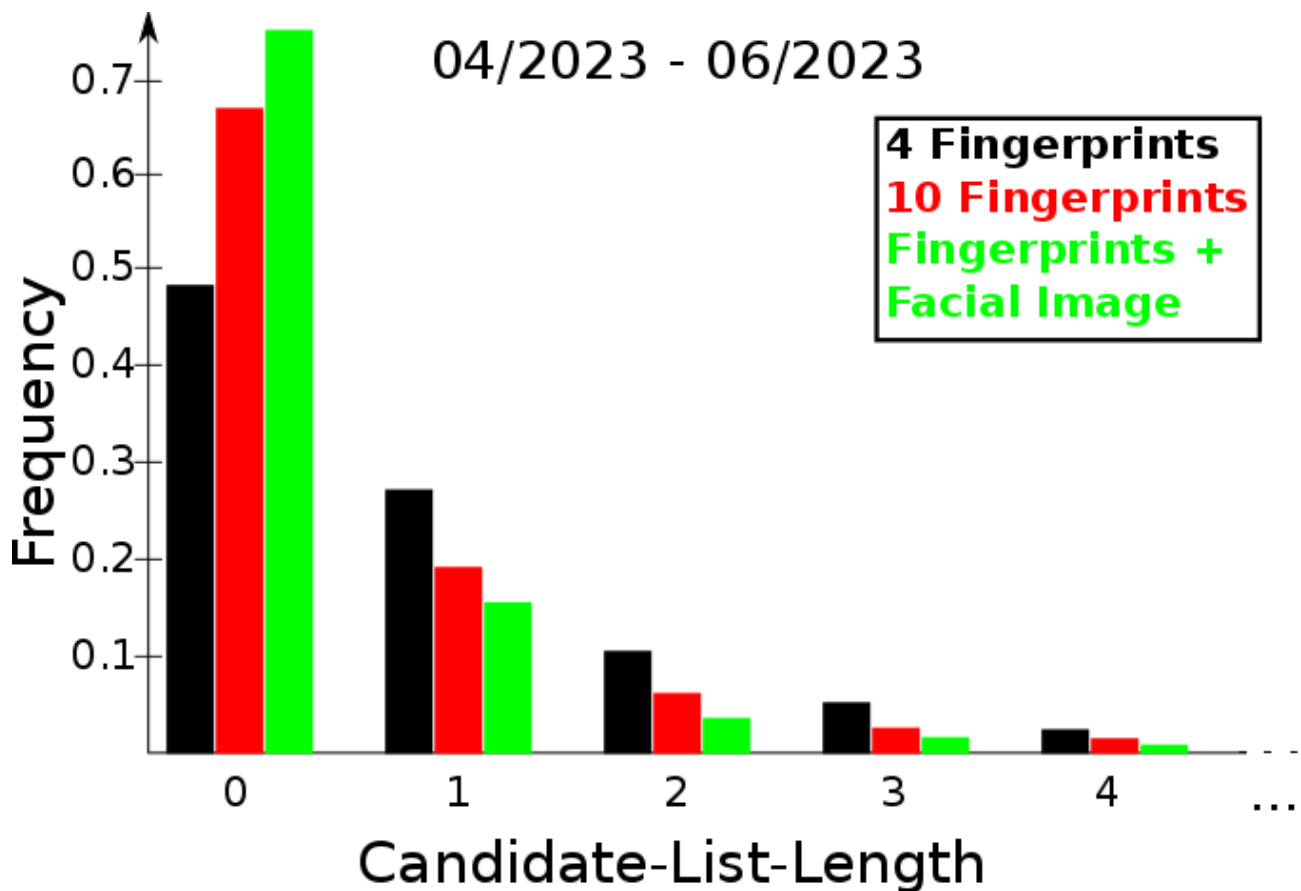

Figure 5.10. Example Grouped Bar Plot

5.13.1.13. Table Types

For all table types defined subsequently, the following applies:

- Input data for table representation SHALL never be trimmed by any means.
- Rows SHALL be visually separated, e.g. by alternating background colour.

An example table is depicted by Figure 5.11.

Figure 5.11. Example Table with Alternation Background Colour

5.13.1.14. Lookup Tables

A lookup table is designated to convey the exact values of a plot or graphic to the viewer. The following applies:

- Only the aggregated or processed absolute or relative data which is the direct input for a plot or graphic SHALL be present in the lookup table if not specified otherwise.
- A plot or graphic SHALL be reproducible, in terms of required data, only by using its corresponding lookup table.

5.13.1.14.1. Lookup Tables Heat Map

For lookup tables for heat maps the following applies:

- It is RECOMMENDED to separate relative and absolute frequencies in separated lookup tables.
- Row and column sums, means and medians SHALL be present for the absolute frequency table.
- Total sum, mean and median SHALL be present for the absolute frequency table.

The lookup table for absolute frequencies is defined by the table definition in Table 5.14.

Attribute	Value
Name	Heat map absolute frequencies lookup table
Purpose	Presenting absolute frequencies and distribution summaries of the input data for a given heat map broken down by the heat map’s dimensions.
Row Labelling	The row dimension of the heat map.
Column Labelling	The column dimension of the heat map.
Cell	The absolute frequency of the heat map’s figure of interest.
Miscellaneous	The column and row sum, median and mean shall be present in the lookup table.

Table 5.14. Heat Map Absolute Frequency Lookup Table Definition

An exemplary heat map lookup table for absolute frequencies is depicted in Table 5.15.

		Var1					
		Val1.1	Val1.2	Val1.3	Row Sum	Row Mean	Row Median
	Val2.1	Count 4	Count 5	Count 6	Sum Val2.2	Mean Val2.2	Median Val2.2
	Val2.2	Count 7	Count 8	Count 9	Sum Val2.3	Mean Val2.3	Median Val2.3
	Val2.3	Count 10	Count 11	Count 12	Sum Val2.4	Mean Val2.4	Median Val2.4
	Val2.4	Count 1	Count 2	Count 3	Sum Val2.1	Mean Val2.1	Median Val2.1
	Column Sum	Sum Val1.1	Sum Val1.2	Sum Val1.3	Total Sum		
	Column Mean	Mean Val1.1	Mean Val1.2	Mean Val1.3		Total Mean	
	Column Median	Median Val1.1	Median Val1.2	Median Val1.3			Total Median

Table 5.15. Example Heat Map Lookup Table Absolute Frequencies

The lookup table for relative frequencies is defined by the table definition in Table 5.16.

Attribute	Value
Name	Heat map absolute frequencies lookup table
Purpose	Presenting relative frequencies and distribution summaries of the input data for a given heat map broken down by the heat map's dimensions.
Row Labelling	The row dimension of the heat map.
Column Labelling	The column dimension of the heat map.
Cell	The relative frequency of the heat map's figure of interest.

Table 5.16. Heat Map Absolute Frequency Lookup Table Definition

An exemplary heat map lookup table for relative frequency is depicted in Table 5.17.

		Var1		
		Val1.1	Val1.2	Val1.3
Var2	Val2.1	Share 4	Share 5	Share 6
	Val2.2	Share 1	Share 2	Share 3

Table 5.17. Example Heat Map Lookup Table for Relative Frequencies

5.13.1.14.2. Lookup Table Histogram

For lookup table for histograms the following applies:

- For every bin, its name, value and cumulative probability SHALL be present in the lookup table.

- Mean and median SHALL be listed in the lookup table.
- The sum of the input variable SHALL be listed at the end of the lookup table.

The lookup table for histograms is defined by the table definition in Table 5.18.

Attribute	Value
Name	Histogram lookup table
Purpose	Presenting relative frequencies and distribution summaries of the input data for a given histogram as well as cumulative probabilities.
Row Labelling	The bin variable of the histogram. Median and Mean shall be present.
Column Labelling	<ul style="list-style-type: none"> • a column representing the absolute frequencies of the bin • a column representing the relative frequencies of the bin • a column representing the empirical cumulative probability of the bin
Cell	The relative, absolute frequencies or cumulative probability of the histogram’s figure of interest.
Miscellaneous	The absolute sum of the histogram’s figure of interest shall be present in the lookup table.

Table 5.18. Histogram Lookup Table Definition

An exemplary histogram lookup table is depicted in Table 5.19.

Bin	Absolute Bin Value	Relative Bin Value	Empirical Cumulative Probability
Bin name 1	Bin value 1	Relative Bin value 1	Cumulative probability 1
Bin name 2	Bin value 2	Relative Bin value 2	Cumulative probability 2
...
Mean	Mean value		
...
Median	Median value		0.5
...
Bin name <i>n-1</i>	Bin value <i>n-1</i>	Relative Bin value <i>n-1</i>	Cumulative probability <i>n-1</i>
Bin name <i>n</i>	Bin value <i>n</i>	Relative Bin value <i>n</i>	Cumulative probability <i>n</i>
Sum	Sum value		

Table 5.19. Example Histogram Lookup Table

5.13.1.14.3. Lookup Table Stacked Bar Plot

For lookup tables for stacked bar plots the following applies:

- For every bar, its absolute and relative frequencies SHALL be present.
- It is RECOMMENDED to separate absolute and relative frequencies in separate lookup tables.
- The sum of the values of the intra and inter bar variables SHALL be present in the absolute count lookup table.
- The total sum of counts SHALL be present in the absolute count lookup table.

Note, a stacked bar plot M have only a single stacked bar. In this case, no inter bar variable exists and row and sum columns SHALL be omitted.

The lookup table for absolute frequency stacked bar plot lookup table is defined by the table definition in Table 5.20.

Attribute	Value
Name	Absolute frequency stacked bar plot lookup table
Purpose	Presenting absolute frequencies and sums of the input data for a given stacked bar plot.
Row Labelling	<ul style="list-style-type: none"> The stacked bar plot's intra bar variable. A column sum row.
Column Labelling	<ul style="list-style-type: none"> The stacked bar plot's inter bar variable. A row sum column.
Cell	The absolute frequencies of figure of interest for the stacked bar plot's partitions.
Miscellaneous	The absolute sum of the stacked bar plot's figure of interest shall be present in the lookup table.

Table 5.20. Absolute Frequency Stacked Bar Plot Lookup Table Definition

An exemplary absolute frequency stacked bar plot lookup table is depicted in Table 5.21.

		Inter Bar Variable				
		Val1.1	Val1.2	Val1.3	Val1.4	
Inter Bar Variable	Val2.1	Count	Count	Count	Count	Sum Val2.1
	Val2.2	Count	Count	Count	Count	Sum Val2.2
	Val2.3	Count	Count	Count	Count	Sum Val2.3
	Val2.4	Count	Count	Count	Count	Sum Val2.4
	Val2.5	Count	Count	Count	Count	Sum Val2.1
Sum		Sum Val1.1	Sum Val1.2	Sum Val1.3	Sum Val1.4	Total Sum

Table 5.21. Example Absolute Frequency Stacked Bar Plot Lookup Table

The lookup table for relative frequency stacked bar plot lookup table is defined by the table definition in Table 5.22.

Attribute	Value
Name	Relative frequency stacked bar plot lookup table
Purpose	Presenting relative frequencies of the input data for a given stacked bar plot.
Row Labelling	The stacked bar plot's intra bar variable.
Column Labelling	The stacked bar plot's inter bar variable.
Cell	The relative frequencies of figure of interest for the stacked bar plot's partitions.

Table 5.22. Relative Frequency Stacked Bar Plot Lookup Table Definition

An exemplary relative frequency stacked bar plot lookup table is depicted in Table 5.23.

		Inter Bar Variable		
		Val1.1	Val1.2	Val1.3
Intra Bar Variable	Val2.1	Share 1	Share 2	Share 3
	Val2.2	Share 4	Share 5	Share 6

Table 5.23. Example Relative Frequency Stacked Bar Plot Lookup Table

5.13.1.14.4. Lookup Table for Box Plots

For lookup table for box plots the following applies:

- For every box, its minimum, first and third quartile, median, mean and maximum SHALL be present.

The lookup table for box plots is defined by the table definition in Table 5.24.

Attribute	Value
Name	Box plots lookup table
Purpose	Presenting the distribution metrics for each box of the box plot.
Row Labelling	The box group variable.
Column Labelling	The distribution metrics.
Cell	The value of the distribution metric for the relevant box group.

Table 5.24. Box Plot Lookup Table Definition

An exemplary box plot lookup table is depicted in Table 5.25.

		Distribution Metric					
		Min.	1. Qu.	Median	Mean	3. Qu.	Max
Box Descriptor Variable	Box1 name	val	val	val	val	val	val
	Box2 name	val	val	val	val	val	val

Table 5.25. Example Box Plot Lookup Table

5.13.1.14.5. Top and Bottom Tables

A top or bottom table is a table, ordered by a set of value columns. The following applies:

- “Value columns” SHALL be columns of the table which shall be considered and which are decisive for the ordering of the rows.
- A fixed number of rows SHALL be present. If the number of rows to display is not defined by the evaluation, the default number shall be 20 rows.
- In case of a top table, the table SHALL be ordered descending regarding the considered set of value columns and the row with the highest order SHALL be the first row of the table. In case of a bottom table, the table SHALL be ordered ascending by the set of value columns and the row with the lowest order shall be the first row of the table.
- The ordering SHALL be conducted in the order of the value columns defined in the respective evaluation. In case of ties, the next value column of the set shall be evaluated.

- If ties can not be resolved, the rank for same ranked rows SHALL be equal. The rank SHALL continue in the original order for following rows.
- In case relative frequencies are in the set of value columns, a goodness indicator SHALL be present to estimate the meaningfulness of the relative frequency i.e. the denominator of the relative frequency SHALL be the goodness estimator.
- A rank column SHALL be present giving the rank of the record according to the ordering by the value columns.
- The value columns SHALL be highlighted in the table header and a remark SHALL denote which columns are used for the ordering.
- The ordering SHALL be unambiguous so that it is clear in which ordering the different rows appear in the table. This MAY be realised by ordering the rows by a name column. If the rows differ only by the name the rank SHALL be equal for all of those rows.

The top and bottom table is defined by the table definition in Table 5.26.

Attribute	Value
Name	Top and bottom table
Purpose	Presenting records with lowest and highest rank according to a set of variables.
Row Labelling	The records.
Column Labelling	The records variables.
Cell	The value of the record variable for the given record.

Table 5.26. Top and Bottom Table Definition

An exemplary top table is depicted in Table 5.27.

Rank	Goodness Estimator	Value Column 1	Value Column 2	Value Column 3	Column 4	Column 5	Column 6
1	891	val	val	val	val	val	val
2	753	val	val	val	val	val	val

Table 5.27. Example Top Table

An exemplary bottom table is depicted in Table 5.28.

Rank	Goodness Estimator	Value Column 1	Value Column 2	Value Column 3	Column 4	Column 5	Column 6
82	4	val	val	val	val	val	val
81	27	val	val	val	val	val	val

Table 5.28. Example Bottom Table

5.13.1.14.6. Component Usage Table

A component usage table presents the type and usage period of components of interest. Components can be hardware or software components. The following applies:

- The first and last day of operation in the reporting period SHALL be present.
- Component descriptors SHALL be present i.e. the triple vendor, name and version of the component.

- The number of occurrences and number of locations using the component in the reporting period SHALL be present.

The component usage table is defined by the table definition in Table 5.29.

Attribute	Value
Name	Component usage table
Purpose	Allowing to investigate the type and number of used components in the reporting period as well as investigating the first and last day of operation of the components in the report period.
Row Labelling	The components
Columns	<ul style="list-style-type: none"> • A consecutive numbering column, starting with 1 • Vendor, name, version and firmware version of the component • First day of operation in the reporting period • Last day of operation in the reporting period • Number of occurrences • Number of distinct locations with at least one occurrence of the component
Data Source	<ul style="list-style-type: none"> • The component usage table always refers to XML nodes of type <code>type.component</code> • An available location or host data field shall be used to calculate the number of distinct locations or hosts which used the component at least once in the reporting period. • An XML node <code>StartTime</code> must be used for period filtering and calculation of first and last day of operation
Miscellaneous	The table shall be ordered by the number of occurrences.

Table 5.29. Component Usage Table Definition

An exemplary component usage table is depicted in Table 5.30.

	Vendor	Name	Version	Firmware Version	First Day of Operation	Last Day of Operation	Number of Occurrences	Number of Locations
1.	XYZ	XYZ2	1.2	12 Test	03.01.1999	04.01.1999	744	32
2.	XYZ	XYZ1	3.2	6.4.2	01.01.1999	06.01.1999	345	12

Table 5.30. Example Component Usabe Table

5.13.1.14.7. Threshold Configuration Table

A threshold configuration table presents the configured threshold of a component. The following applies:

- The first and last day of operation in the reporting period SHALL be present.
- Component descriptors SHALL be present i.e. the triple vendor, name and version of the component.
- The number of occurrences and number of locations using the component in the reporting period SHALL be present.

The component usage table is defined by the table definition in Table 5.31.

Attribute	Value
Name	Threshold Configuration table

Attribute	Value
Purpose	Allowing to investigate the configured thresholds in the report period.
Row Labelling	configured thresholds
Columns	<ul style="list-style-type: none"> • A consecutive numbering column, starting with 1 • Vendor, name, version and firmware version of the component • The first day the configuration was logged in the reporting period • The last day the configuration was logged in the reporting period • The optional ID to note the ID of the corresponding measurement. • Configured lower bound of the possible range • Configured upper bound of the possible range • Number of occurrences • Number of distinct locations with at least one occurrence of the component
Data Source	<ul style="list-style-type: none"> • The threshold configuration table refers to XML nodes of type <code>type.configuration.parameters</code>, <code>type.value.with.threshold</code>, <code>type.finger.quality.integer</code> and a XML node of type <code>type.component</code> on the same hierarchy level or the first node of type <code>type.component</code> on a higher level. • The column “Lower Bound” refers to XML nodes <code>tmin</code> • The column “Upper Bound” refers to XML nodes <code>tmax</code> • An available location or host data field SHALL be used to calculate the number of distinct locations or hosts which used the component at least once in the reporting period. • An XML node <code>StartTime</code> must be used for period filtering and calculation of first and last day of operation • Note, that depending on the context a component may have several threshold for different measurements configured e.g. a face image quality component may evaluate a facial image on several different indicators or different thresholds are configured for different fingers. In those cases, an optional ID column SHALL be used to note the ID of the corresponding measurement, finger code etc. • Note, if only a threshold is specified and no upper and lower bounds, a single threshold column SHALL replace the lower and upper bound columns.
Miscellaneous	The table SHALL be ordered by the number of occurrences.

Table 5.31. Threshold Configuration Table Definition

An exemplary threshold configuration table is depicted in Table 5.32.

	Vendor	Name	Version	Firmware Version	First Day of Configuration	Last Day of Configuration	ID	Lower bound	Upper bound	Number of Occurrences	Number of Locations
1	XYZ	XYZ2	1.2	12 Test	03.01.1999	04.01.1999	001	0	60	744	32
2	XYZ	XYZ1	3.2	6.4.2	01.01.1999	06.01.1999	002	0.4	1	345	12

Table 5.32. Example Threshold Configuration Table

5.13.1.14.8. Lookup Table for Line Plots

For lookup tables for line plots the following applies:

- For every line, its absolute and relative frequencies SHALL be present. If there is only one line in the plot there shall be no relative frequencies.
- It is RECOMMENDED to separate absolute and relative frequencies in separate lookup tables.
- The sum of the X-axis and Y-axis variable SHALL be present in the absolute count lookup table.
- The total sum of counts SHALL be present in the absolute count lookup table.

The absolute frequency line plot lookup table is defined by the table definition in Table 5.33.

Attribute	Value
Name	Absolute frequency line plot lookup table
Purpose	Presenting absolute frequencies and sums of the input data for a given line plot.
Row Labelling	<ul style="list-style-type: none"> • The stacked line plot’s Y-axis variable. • A row called “Sum” which shows all the sums of the values of each column.
Column Labelling	<ul style="list-style-type: none"> • The stacked line plot’s X-axis variable. • A column called “Sum” which shows all the sums of the values of each row.
Cell	The absolute frequencies of figure of interest for the line plots data points.
Miscellaneous	The absolute sum of the line plot’s figure of interest SHALL be present in the lookup table.

Table 5.33. Absolute Frequency Line Plot Lookup Table Definition

An exemplary absolute frequency line plot lookup table is depicted in Table 5.34.

		X-Axis Variable				
		Val1.1	Val1.2	Val1.3	Val1.4	Sum
Y-Axis Variable	Val2.1	Count	Count	Count	Count	Sum Val2.1
	Val2.2	Count	Count	Count	Count	Sum Val2.2
	Val2.3	Count	Count	Count	Count	Sum Val2.3
	Val2.4	Count	Count	Count	Count	Sum Val2.4
	Val2.5	Count	Count	Count	Count	Sum Val2.1
	Sum	Sum Val1.1	Sum Val1.2	Sum Val1.3	Sum Val1.4	Total Sum

Table 5.34. Example Absolute Frequency Line Plot Lookup Table

The lookup table for relative frequency line plot lookup table is defined by the table definition in Table 5.35.

Attribute	Value
Name	Relative frequency stacked line plot lookup table
Purpose	Presenting relative frequencies of the input data for a given line plot.
Row Labelling	The line plot’s X-axis variable.
Column Labelling	The line plot’s Y-axis variable.
Cell	The relative frequencies of a figure of interest for the line plot’s partitions.

Table 5.35. Relative Frequency Line Plot Lookup Table Definition

An exemplary relative frequency line plot lookup table is depicted in Table 5.36.

		X-Axis Variable		
		Val1.1	Val1.2	Val1.3
Y-Axis Variable	Val2.1	Share 1	Share 2	Share 3
	Val2.2	Share 4	Share 5	Share 6

Table 5.36. Example Relative Frequency Line Plot Lookup Table

5.13.2. FM EVA-ALL-PROCESS

This functional module defines general process evaluations which are not directly related to a biometric modality.

5.13.2.1. Requirements

The evaluations defined by this module SHALL be provided if the application specific EVA-ALL module requires them.

5.13.2.2. Number of Acquisition Processes

Attribute	Value
ID	ALL-PROCESS-1
Name	Number of acquisition processes
Purpose	This evaluation SHALL deliver insights into the number of acquisition processes.
Plots	Line Plot (Table 5.38)
Tables	Lookup table for line plot (Table 5.38)

Table 5.37. Evaluation Number of Acquisition Processes

Attribute	Value
Name	Line plot of number of acquisition processes
Purpose	This line plot depicts the number of acquisition processes by type.
Type	Line plot
X-Axis	Time, calendar weeks if yearly report, days if monthly report.
Y-Axis	Number of processes
Data Source	<ul style="list-style-type: none"> The number of XML nodes <code>FingerAcquisition</code> for Y-axis if relevant for the application profile, if finger acquisition is conducted in the domain The number of XML nodes <code>FaceAcquisition</code> for Y-axis if relevant for the application profile, if face acquisition is conducted in the domain The number of XML nodes <code>IrisAcquisition</code> for Y-axis if relevant for the application profile, if iris acquisition is conducted in the domain The XML node <code>FingerAcquisition/StartTime</code> for period filtering and X-axis, if finger acquisition is not conducted in the domain, face or iris element SHALL be used to extract the start time

Attribute	Value
Miscellaneous	The X-Axis SHALL span over the last six months if a monthly report is generated.
Example Visualisation	Will be amended in a future version of this guideline.

Table 5.38. Line Plot Number of Acquisition Processes

5.13.2.3. Identification Process Duration

Attribute	Value
ID	ALL-PROCESS-2
Name	Identification process duration
Purpose	This evaluation SHALL deliver insights into the duration of identification processes. Thereby, e.g. the detection of identifications with long duration is of interest.
Facet	<ul style="list-style-type: none"> Modalities used for identification identification System
Plots	<ul style="list-style-type: none"> Histogram (Table 5.40)
Tables	<ul style="list-style-type: none"> Lookup table for histogram (Table 5.40) Top and bottom table (Table 5.42)

Table 5.39. Evaluation Identification Duration

Attribute	Value
Name	Histogram identification process duration
Purpose	This histogram depicts the distribution of the identification process duration. Thereby, e.g. the detection of outliers is of interest.
Type	Histogram with Cumulative Distribution Function
X-Axis	Identification duration
Y-Axis 1	Frequency of identification processes
Y-Axis 2	Axis for empirical cumulative distribution function scaled from 0 to 1.
Trimming	The input data of the histograms SHALL be trimmed by the respective 95% percentile.
Data Source	<ul style="list-style-type: none"> distribution of time difference between XML-Nodes <code>/Identification/SubmitTime</code> and <code>Identification/EndTime</code> in XML-node XML-node <code>Identification/StartTime</code> for period filtering XML-attribute <code>Identification/@system</code> for facet XML-node <code>Identification/Modalities</code> for facet
Example Visualisation	Will be amended in a future version of this guideline.

Table 5.40. Histogram Finger Identification Process Duration

Attribute	Value
Name	Top and bottom table locations by identification process duration median

Attribute	Value
Purpose	Presenting locations with lowest and highest rank according to the identification processes duration median
Row	The finger acquisition location.
Columns	<ul style="list-style-type: none"> • Median of identification process duration of the location (EndTime - SubmitTime) • Number of identification process at the location as goodness estimator
Miscellaneous	<ul style="list-style-type: none"> • value column for ordering is the median of identification duration median • ascending order (the lower, the better)
Data Source	<ul style="list-style-type: none"> • An XML-node with location or host information for location column. This data may also be located in sources external to this Technical Guideline. • XML-nodes Identification/SubmitTime and Identification/EndTime for the median duration calculation • XML-node Identification/StartTime for period filtering • Attributable Identification/@system for facet • XML-node Identification/Modalities for facet

Table 5.41. Top and Bottom Locations by Finger Identification Process Duration

5.13.2.4. Identification Process Result

Attribute	Value
ID	ALL-PROCESS-4
Name	Identification process result
Purpose	This evaluation SHALL deliver insights into the result of identification processes. Thereby, e.g. the detection of identifications with high number of hits is of interest.
Facet	<ul style="list-style-type: none"> • Modalities used for identification • Identification System
Plots	<ul style="list-style-type: none"> • Stacked Bar Plot (Table 5.43) • Histogram (Table 5.45)
Tables	<ul style="list-style-type: none"> • Lookup table for stacked bar plot (Table 5.43) • Lookup table for histogram (Table 5.45) • Top and bottom table for Identification Process Result (Table 5.44) • Threshold Configuration Table <ul style="list-style-type: none"> • use XML-node Identification/System for component information if present. If this information is not present or only part of the information is available for the table, omit the corresponding columns. • use XML-node Verification Identification/Candidates/Candidate/AchievedFMR or if not existing RawScore for threshold information.

Table 5.42. Evaluation Identification Process Result

Attribute	Value
Name	Stacked bar plot global identification result
Purpose	This stacked bar plot SHALL deliver insights into how frequently an identification is successfully on a global scope.
Type	Stacked Bar Plot (horizontal)

Attribute	Value
X-Axis	Relative frequencies of identification results.
Data Source	<ul style="list-style-type: none"> • distribution XML-Nodes Identification/Result for X-axis. • XML-node Identification/StartTime for period filtering • XML-attribute Identification/@system for facet • XML-node Identification/Modalities for facet
Example Visualisation	Will be amended in a future version of this guideline.

Table 5.43. Stacked Bar Plot Global Identification Process Result

Attribute	Value
Name	Top and bottom table locations by successful identification result.
Purpose	Presenting locations with lowest and highest rank according to the identification processes result successful
Row	The finger acquisition location.
Columns	<ul style="list-style-type: none"> • Relative frequencies of successful identification processes at the location (Value) • Number of identification process at the location as goodness estimator
Miscellaneous	<ul style="list-style-type: none"> • ascending order (the lower, the better)
Data Source	<ul style="list-style-type: none"> • An XML-node with location or host information for location column. This data may also be located in sources external to this Technical Guideline. • XML-nodes Identification/Result for value column • XML-node Identification/StartTime for period filtering • XML-attribute Identification/@system for facet • XML-node Identification/Modalities for facet

Table 5.44. Top and Bottom Locations by Identification Process Result

Attribute	Value
Name	Histogram identification candidate’s achieved FMR
Purpose	This histogram depicts the distribution of the identification candidate’s achieved FMR. Thereby, e.g. the detection of unusual distribution characteristics is of interest.
Type	Histogram with Cumulative Distribution Function
X-Axis	Identification candidate’s achieved FMR
Y-Axis 1	Frequency of identifications
Y-Axis 2	Axis for empirical cumulative distribution function scaled from 0 to 1.
Miscellaneous	If the applied threshold is equal over all candidates, the threshold SHALL be added as vertical line to the histogram.
Data Source	<ul style="list-style-type: none"> • XML-nodes Identification/Candidates/Candidate/AchievedFMR • XML-attribute Identification/Candidates/Candidate/AchievedFMR/@threshold • XML-node Identification/StartTime for period filtering • XML-attribute Identification/@system for facet • XML-node Identification/Modalities for facet

Attribute	Value
Example Visualisation	Will be amended in a future version of this guideline.

Table 5.45. Histogram Finger Identification Candidate's Achieved FMR

5.13.2.5. Single Verification Process Result

Attribute	Value
ID	ALL-PROCESS-6
Name	Verification process results
Purpose	This evaluation SHALL deliver insights into the result of verification processes. Thereby, e.g. the global relative frequency of failed verifications is of interest.
Facet	<ul style="list-style-type: none"> Modalities used for verification Identification System
Plots	<ul style="list-style-type: none"> Stacked Bar Plot (Table 5.47) Histogram (Table 5.48)
Tables	<ul style="list-style-type: none"> Lookup table for stacked bar plot (Table 5.47) Lookup table for histogram (Table 5.48) Top and bottom table for (Table 5.47) Threshold Configuration Table <ul style="list-style-type: none"> use XML-node <code>Verification/Verification/Software</code> for component information use XML-node <code>Verification/SingleVerification/Comparison/AchievedFMR</code> or if not existing <code>RawScore</code> for threshold information.

Table 5.46. Evaluation Single Verification Process Result

Attribute	Value
Name	Stacked bar plot global verification result
Purpose	This stacked bar plot SHALL deliver insights into how frequently a verification is successfully on a global scope.
Type	Stacked Bar Plot (horizontal)
X-Axis	Relative frequencies of verification results.
Data Source	<ul style="list-style-type: none"> distribution XML-attribute <code>Verification/@result</code> for X-axis. XML-node <code>Verification/StartTime</code> for period filtering XML-attribute <code>Verification/@system</code> for facet XML-node <code>Verification/Modalities</code> for facet
Example Visualisation	Will be amended in a future version of this guideline.

Table 5.47. Stacked Bar Plot Global Single Verification Process Result

Attribute	Value
Name	Histogram verification achieved FMR
Purpose	This histogram depicts the distribution of the verification's achieved FMR. Thereby, e.g. the detection of unusual distribution characteristics is of interest.

Attribute	Value
Type	Histogram with Cumulative Distribution Function
X-Axis	Verification achieved FMR
Y-Axis 1	Frequency of verifications
Y-Axis 2	Axis for empirical cumulative distribution function scaled from 0 to 1.
Miscellaneous	If the applied threshold is equal over all comparisons, the threshold SHALL be added as vertical line to the histogram.
Data Source	<ul style="list-style-type: none"> • XML-nodes <code>Verification/SingleVerification/Comparison/AchievedFMR</code> • XML-attribute <code>Verification/SingleVerification/Comparison/AchievedFMR/@threshold</code> • XML-node <code>Verification/StartTime</code> for period filtering • XML-attribute <code>Verification/@system</code> for facet • XML-node <code>Verification/Modalities</code> for facet
Example Visualisation	Will be amended in a future version of this guideline.

Table 5.48. Histogram Single Verification Achieved FMR

5.13.2.6. Single Verification Process Duration

Attribute	Value
ID	ALL-PROCESS-7
Name	Verification process duration
Purpose	This evaluation SHALL deliver insights into the duration of verification processes. Thereby, e.g. the detection of verification with long duration is of interest.
Facet	<ul style="list-style-type: none"> • Modalities used for verification • Verification System
Plots	<ul style="list-style-type: none"> • Histogram (Table 5.50) per verification system and modalities used
Tables	<ul style="list-style-type: none"> • Lookup table for histogram (Table 5.50) per verification system and modalities used • Top and bottom table (Table 5.51) per verification system and modalities used.

Table 5.49. Evaluation Single Verification Process Duration

Attribute	Value
Name	Histogram verification process duration
Purpose	This histogram depicts the distribution of the verification process duration. Thereby, e.g. the detection of outliers is of interest.
Type	Histogram with Cumulative Distribution Function
X-Axis	Verification duration
Y-Axis 1	Frequency of verification processes
Y-Axis 2	Axis for empirical cumulative distribution function scaled from 0 to 1.
Trimming	The input data of the histograms SHALL be trimmed by the respective 95% percentile.
Data Source	<ul style="list-style-type: none"> • distribution of time difference between XML-Nodes

Attribute	Value
	/Verification/StartTime and Verification/EndTime in XML-node <ul style="list-style-type: none"> • XML-node Verification/StartTime for period filtering • XML-attribute Verification/@system for facet • XML-node Verification/Modalities for facet
Example Visualisation	Will be amended in a future version of this guideline.

Table 5.50. Histogram Single Verification Process Duration

Attribute	Value
Name	Top and bottom table locations by verification process duration median
Purpose	Presenting locations with lowest and highest rank according to the verification processes duration median
Row	The finger acquisition location.
Columns	<ul style="list-style-type: none"> • Median of verification process duration of the location (EndTime - StartTime) • Number of verification process at the location as goodness estimator
Miscellaneous	<ul style="list-style-type: none"> • value column for ordering is the median of verification duration median • ascending order (the lower, the better)
Data Source	<ul style="list-style-type: none"> • An XML-node with location or host information for location column. This data may also be located in sources external to this Technical Guideline. • XML-nodes Verification/StartTime and Verification/EndTime for the median duration calculation • XML-node Verification/StartTime for period filtering • XML-attribute Verification/@system for facet • XML-node Verification/Modalities for facet

Table 5.51. Top and Bottom Locations by Single Verification Process Duration

5.13.3. FM EVA-ALL-AAD

This functional module defines general evaluations for the Arrival Attestation Document application profiles.

5.13.3.1. Requirements

The evaluations specified by this module SHALL be provided for the Arrival Attestation Document application profiles. In addition all evaluation defined by Table 5.52 SHALL be provided. The requirements by EVA-ALL-GENERIC SHALL apply.

ID	Remark
ALL-PROCESS-1	
ALL-PROCESS-2	Identification by CIR.
ALL-PROCESS-3	Identification by CIR.
ALL-PROCESS-3	Identification by CIR.
ALL-PROCESS-5	

Table 5.52. Required Evaluations EVA-ALL-AAD

5.13.4. FM EVA-FP-GENERIC

This functional module defines requirements for the evaluation of fingerprint acquisitions.

5.13.4.1. Requirements

The evaluations defined by this module SHALL be provided if the application specific EVA-FP module requires them. The evaluations related to Finger Capture Attempts SHALL be provided if finger capture attempts occur in the relevant application profile.

5.13.4.2. Finger Capture Components

Attribute	Value
ID	FP-GENERIC-1
Name	Software and hardware version of finger capture
Purpose	This evaluation SHALL give insights in the used software and hardware for capturing fingers during the report period.
Plots	<ul style="list-style-type: none"> Heat Map finger acquisition software usage (Table 5.54) Heat Map finger hardware usage (Table 5.55)
Tables	<ul style="list-style-type: none"> Lookup table for heat maps Table 5.54 and Table 5.55) Component Usage Tables for <ul style="list-style-type: none"> software of finger acquisition XML node <code>FingerAcquisition/Software/</code> hardware of finger acquisition XML node <code>FingerAcquisition/Hardware/</code>

Table 5.53. Evaluation Finger Capture Component

Attribute	Value
Name	Heat map of the number of finger acquisitions by software version
Purpose	This heat map depicts the distributions of the number of finger acquisitions by software version and time to recognize e.g. new software versions and their introduction phase.
Type	Heat Map
Row Labelling	The finger acquisition software version
Column Labelling	Time, calendar week if yearly report, day if monthly report
Cells	The frequency of finger acquisitions with the given software version
Data Source	<ul style="list-style-type: none"> The number of XML nodes <code>FingerAcquisition</code> for the cell counts The XML nodes <code>FingerAcquisition/Software</code> for the row dimension XML node <code>FingerAcquisition/StartTime/</code> for period filtering and the column dimension
Colours	Maximum: "column wise" (case 1)
Example Visualisation	Will be amended in a future version of this guideline.

Table 5.54. Heat Map Finger Acquisitions by Software

Attribute	Value
Name	Heat map of the number of finger acquisitions by hardware version

Attribute	Value
Purpose	This heat map depicts the distributions of the number of finger acquisitions by hardware version over a given period to recognize e.g. detect new hardware versions and their introduction phase.
Type	Heat Map
Row Labelling	The finger acquisition hardware version
Column Labelling	Time, calendar week if yearly report, day if monthly report
Cells	The count of finger acquisitions with the relevant hardware version
Data Source	<ul style="list-style-type: none"> The number of XML nodes <code>FingerAcquisition</code> for the cell counts The XML nodes <code>FingerAcquisition/Hardware/Version</code> for the row dimension XML node <code>FingerAcquisition/StartTime</code> for period filtering and the column dimension
Colours	Maximum: "column wise" (case 1)
Example Visualisation	Will be amended in a future version of this guideline.

Table 5.55. Heat Map Finger Acquisitions by Hardware

5.13.4.3. Number of Finger Captures

Attribute	Value
ID	FP-GENERIC-2
Name	Number of finger captures
Purpose	This evaluation SHALL give insights in the number of captures needed to digitise a finger. Thereby, e.g. the detection of digitization problems is of interest.
Plots	Stacked Bar Plot (Table 5.57)
Tables	<ul style="list-style-type: none"> Lookup table for stacked bar plot (Table 5.57) Top and bottom table (Table 5.58)
Facet	Finger capture mode

Table 5.56. Evaluation Number of Finger Captures

Attribute	Value
Name	Stacked bar plot for the number of necessary captures for finger digitalization
Purpose	This stacked bar plot depicts the number of finger captures needed to digitise a finger for a given period to recognize e.g. global high number of necessary attempts to capture a finger.
Type	Stacked Bar Plot (horizontal)
X-Axis	Relative frequencies of the observed counts of finger captures needed to digitise a finger.
Miscellaneous	At maximum a count of nine SHALL be depicted. All exceeding counts SHALL be summarised in a single category (only for plot, not for lookup table).
Data Source	<ul style="list-style-type: none"> XML-attribute <code>FingerAcquisition/FingerCapture/@count</code> for the X-axis XML node <code>FingerAcquisition/StartTime</code> for period filtering XML node <code>FingerAcquisition/FingerCaptureMode</code> for facet

Attribute	Value
Example Visualisation	Will be amended in a future version of this guideline.

Table 5.57. Stacked Bar Plot Number of Finger Captures

Attribute	Value
Name	Top and bottom table locations with high number of finger captures
Purpose	Presenting locations with lowest and highest rank according to the mean of needed finger capture per finger.
Row Labelling	The finger acquisition location.
Columns	<ul style="list-style-type: none"> • Mean of number of captures per finger capture (Value) • Number of finger captures as goodness estimator
Miscellaneous	<ul style="list-style-type: none"> • value column for ordering is the mean of number of captures per finger capture • ascending order (the lower, the better)
Data Source	<ul style="list-style-type: none"> • XML-attribute <code>FingerAcquisition/FingerCapture/@count</code> for mean • number of <code>FingerAcquisition</code> as goodness estimator column • An XML-node with location or host information for location column. This data may also be located in sources external to this Technical Guideline. • XML node <code>FingerAcquisition/StartTime</code> for period filtering • XML node <code>FingerAcquisition/FingerCaptureMode</code> for facet

Table 5.58. Top and Bottom Locations by Finger Capture Count Mean

5.13.4.4. Number of Finger Captures by Time

Attribute	Value
ID	FP-GENERIC-4
Name	Number of finger captures by finger
Purpose	This evaluation SHALL give insights in the number of needed finger captures by finger. Thereby, e.g. the detection of fingers with low and high numbers of needed finger captures is of interest.
Facet	Finger capture mode
Plots	Stacked bar plot (Table 5.60)
Tables	Absolute and relative lookup table for stacked bar plot (Table 5.60)

Table 5.59. Evaluation Number of Finger Captures by Finger

Attribute	Value
Name	Stacked bar plot of the number of finger captures by finger
Purpose	This stacked bar plot depicts the number of finger captures by finger to e.g. identify fingers with low or high number of finger captures.
Type	Stacked Bar Plot (vertical)
X-Axis	Finger code

Attribute	Value
Y-Axis	Relative frequency of the number of captures scaled from 0 to 1.
Data Source	<ul style="list-style-type: none"> XML-attribute <code>FingerAcquisition/FingerCapture/@count</code> for the Y-axis XML-attribute <code>FingerAcquisition/FingerCapture/@fc</code> for the X-axis XML node <code>FingerAcquisition/StartTime</code> for period filtering XML node <code>FingerAcquisition/FingerCaptureMode</code> for facet
Example Visualisation	Will be amended in a future version of this guideline.

Table 5.60. Stacked Bar Plot Number of Finger Captures by Finger

5.13.4.5. Rejection Reasons of Finger Capture Attempts

Attribute	Value
ID	FP-GENERIC-6
Name	Rejection Reasons of finger capture attempts by finger
Purpose	This evaluation SHALL give insights in the rejection reasons of finger capture attempts by finger needed to digitise a finger. Thereby, e.g. the detection of fingers with specific sensor problems is of interest.
Plots	Stacked Bar Plot (Table 5.62)
Tables	Lookup table for stacked bar plot (Table 5.62)
Facet	Finger capture mode

Table 5.61. Evaluation Rejection Reason of Finger Capture Attempts by Finger

Attribute	Value
Name	Stacked bar plot for the rejection reasons of finger capture attempts by finger
Purpose	This stacked bar plot depicts the rejection reasons of finger capture attempts occurred for a given period to recognize e.g. globally unusual balances of sensor errors.
Type	Stacked Bar Plot (vertical)
X-Axis	Finger code
Y-Axis	Relative frequencies of finger capture rejection reasons. If the rejection reason is “other”, the error code SHALL be used as value in addition e.g. “other, Error Code 5”.
Miscellaneous	If the rejection reason is “other”, the error code SHALL be used as value in addition e.g. “other, Error Code 5”.
Data Source	<ul style="list-style-type: none"> XML-attributes <code>FingerAcquisition/FingerCapture/FingerCaptureAttempt/@rejectionReason</code> and <code>FingerAcquisition/FingerCapture/FingerCaptureAttempt/@errorCode</code> for the X-axis XML node <code>FingerAcquisition/StartTime</code> for period filtering XML-attribute <code>FingerAcquisition/FingerCapture@fc</code> for the X-axis XML node <code>FingerAcquisition/FingerCaptureMode</code> for facet
Example Visualisation	Will be amended in a future version of this guideline.

Table 5.62. Stacked Bar Rejection Reasons of Finger Capture Attempts by Finger

5.13.4.6. Success Rate of Finger Capture Attempts

Attribute	Value
ID	FP-GENERIC-8
Name	Success rate of finger capture attempts by finger
Purpose	This evaluation SHALL give insights in the success rate by finger of finger capture attempts needed to digitise the specific finger. Thereby, the detection of specific fingers with digitisation problems is of interest.
Plots	Stacked Bar Plot (Table 5.64)
Tables	Lookup table for stacked bar plot (Table 5.64)
Facet	Finger capture mode

Table 5.63. Evaluation Success Rate of Finger Capture Attempts

Attribute	Value
Name	Stacked bar plot for the success rate of finger capture attempts by finger
Purpose	This stacked bar plot depicts the success rate by finger of finger capture attempts occurred for a given period to recognize e.g. fingers with high number of failed capture attempts.
Type	Stacked Bar Plot (vertical)
X-Axis	Finger code
Y-Axis	Relative frequencies of successful and not successful finger captures.
Data Source	<ul style="list-style-type: none"> XML-attribute <code>FingerAcquisition/FingerCapture/FingerCaptureAttempt/@acceptableCapture</code> for the Y-axis XML node <code>FingerAcquisition/StartTime</code> for period filtering XML-attribute <code>FingerAcquisition/FingerCapture/@fc</code> for the X-axis XML node <code>FingerAcquisition/FingerCaptureMode</code> for facet
Example Visualisation	Will be amended in a future version of this guideline.

Table 5.64. Stacked Bar Success Rate of Finger Capture Attempts by Finger

5.13.4.7. Number of Finger Captures per Applicant

Attribute	Value
ID	FP-GENERIC-9
Name	Number of finger capture per Applicant
Purpose	This evaluation SHALL give insights in the number finger captures per applicant. Thereby, e.g. the share of applicants with very high number of captures is of interest.
Plots	Histogram (Table 5.66)
Tables	Lookup table for histogram (Table 5.66)

Table 5.65. Number of Finger Captures per Applicant

Attribute	Value
Name	Histogram number of finger captures per applicant

Attribute	Value
Purpose	This histogram depicts the number of finger captures per applicant for a given time period to recognize e.g. groups of applicants with high number of finger captures.
Type	Histogram with Cumulative Distribution Function
X-Axis	Number of captures per applicant
Y-Axis 1	Number of applicants
Y-Axis 2	Axis for empirical cumulative distribution function scaled from 0 to 1.
Data Source	<ul style="list-style-type: none"> distribution of the sum of the XML-attributes <code>FingerAcquisition/FingerCapture/@count</code> per applicant XML node <code>FingerAcquisition/StartTime</code> for period filtering
Miscellaneous	The mean SHALL not be indicated by a vertical line.
Example Visualisation	Will be amended in a future version of this guideline.

Table 5.66. Histogram Number of Finger Capture Attempts per Applicant

5.13.4.8. NFIQ 2.0 Fingerprint Image Quality

Attribute	Value
ID	FP-GENERIC-10
Name	NFIQ 2.0 fingerprint image quality
Purpose	This evaluation SHALL give insights in the NFIQ 2.0 fingerprint image quality. Thereby, e.g. the detection of fingers with quality below defined thresholds is of interest.
Plots	<ul style="list-style-type: none"> Stacked bar Plot (Table 5.68) Histogram (Table 5.69) per finger Box plot (Table 5.70)
Tables	<ul style="list-style-type: none"> Lookup table for histogram (Table 5.69) per finger Lookup table for box plot (Table 5.70) Top and bottom table (Table 5.71) Threshold Configuration Table <ul style="list-style-type: none"> <code>FingerAcquisition/FingerQuality/Software</code> for component information <code>FingerAcquisition/FingerQuality/fp</code> for threshold information.

Table 5.67. Evaluation NFIQ 2.0 Fingerprint Image Quality

Attribute	Value
Name	Stacked bar plot finger quality errors
Purpose	This figure depicts a stacked bar plot of the relative frequencies of finger quality assessments with and without errors. Thereby, e.g. the detection of high numbers of fingers which no quality was measured for is of interest.
Type	Stacked bar plot (horizontal)
X-Axis	Relative frequencies of the finger quality assessments without error and with error (by error code).
Miscellaneous	Note, that the bar segment of fingers with error code SHALL be further segmented by the error code values itself. If the rejection reason is "other", the error code SHALL be used as value in addition e.g. "other, Error Code 5".

Attribute	Value
Data Source	<ul style="list-style-type: none"> counts of XML nodes <code>FingerAcquisition/FingerQuality/</code> with and without <code>FingerAcquisition/FingerQuality/ErrorsCodes</code> XML-nodes <code>FingerAcquisition/FingerQuality/ErrorCode</code> XML node <code>FingerAcquisition/StartTime</code> for period filtering
Example Visualisation	Will be amended in a future version of this guideline.

Table 5.68. Stacked Bar Plot Relative Finger Quality Assessment Errors

Attribute	Value
Name	Histogram NFIQ 2.0 fingerprint image quality per finger
Purpose	This histogram depicts the distribution of NFIQ 2.0 fingerprint image quality for a single finger. Thereby, e.g. the share of fingers below the finger's threshold is of interest.
Type	Histogram with Cumulative Distribution Function
X-Axis	NFIQ 2.0 score scaled from 0 to 100
Y-Axis 1	Number of fingers
Y-Axis 2	Axis for empirical cumulative distribution function scaled from 0 to 1.
Facet	Finger Code
Miscellaneous	<ul style="list-style-type: none"> The histogram SHALL only depict the quality distribution for a single finger. No histogram without facet grouping. A vertical line SHALL indicate the threshold for the finger. The line SHALL be annotated with the numeric threshold and the relative number of fingers below the threshold.
Data Source	<ul style="list-style-type: none"> distribution of XML attribute <code>FingerAcquisition/FingerQuality/fp/@result</code> XML-attribute <code>FingerAcquisition/FingerQuality/fp/@fc</code> for finger filtering XML-attribute <code>FingerAcquisition/FingerQuality/fp/@threshold</code> for threshold of finger XML node <code>FingerAcquisition/StartTime</code> for period filtering
Example Visualisation	Will be amended in a future version of this guideline.

Table 5.69. Histogram NFIQ 2.0 Fingerprint Image Quality

Attribute	Value
Name	Box plot NFIQ 2.0 fingerprint image quality comparison by finger
Purpose	This figure depicts box plots of the distributions of NFIQ 2.0 fingerprint image quality for multiple fingers. Thereby, e.g. the fingers with unusual distribution characteristics SHALL be identified.
Type	Box plot
X-Axis	Finger code
Y-Axis	NFIQ 2.0 score
Data Source	<ul style="list-style-type: none"> distribution of XML-attribute <code>FingerAcquisition/FingerQuality/fp/@result</code> for Y-axis XML-attribute <code>FingerAcquisition/FingerQuality/fp/@fc</code> for X-axis

Attribute	Value
	<ul style="list-style-type: none"> XML node <code>FingerAcquisition/StartTime</code> for period filtering
Example Visualisation	Will be amended in a future version of this guideline.

Table 5.70. Box Plot NFIQ 2.0 Fingerprint Image Quality Finger Comparison

Attribute	Value
Name	Top and bottom table locations by NFIQ 2.0 result
Purpose	Presenting locations with lowest and highest rank according to the NFIQ 2.0 results
Row Labelling	The finger acquisition location.
Columns	<ul style="list-style-type: none"> A column for the median of the NFIQ 2.0 results for each finger (value columns) Number of total finger captures at the location as goodness estimator
Miscellaneous	<ul style="list-style-type: none"> The value column for ordering are the median NFIQ 2.0 columns. The order priority is as follows: right index, left index, right thumb, left thumb, right middle, left middle, right ring, left ring, right little, left little. Note that some fingers may not be available in the application. Rank: descending order (the higher, the better)
Data Source	<ul style="list-style-type: none"> An XML-node with location or host information for location column. This data may also be located in sources external to this Technical Guideline. distribution of XML-attribute <code>FingerAcquisition/FingerQuality/fp/@result</code> for median XML-attribute <code>FingerAcquisition/FingerQuality/fp/@fc</code> for filtering the median columns XML node <code>FingerAcquisition/StartTime</code> for period filtering

Table 5.71. Top and Bottom Locations by NFIQ 2.0 Result

5.13.4.9. Finger Capture Duration

Attribute	Value
ID	FP-GENERIC-11
Name	Finger capture duration
Purpose	This evaluation SHALL give insights in the duration of finger captures. Thereby, e.g. the detection of fingers with long capture duration is of interest.
Plots	<ul style="list-style-type: none"> Histogram (Table 5.73) per finger Box plot (Table 5.74)
Tables	<ul style="list-style-type: none"> Lookup table for histogram (Table 5.73) per finger Lookup table for box plot (Table 5.74) Top and bottom table (Table 5.75)

Table 5.72. Evaluation Finger Capture Duration

Attribute	Value
Name	Histogram finger capture duration per finger
Purpose	This histogram depicts the distribution of the capture duration for a single finger. Thereby, e.g. the detection of outliers is of interest.

Attribute	Value
Type	Histogram with Cumulative Distribution Function
X-Axis	Finger capture duration
Y-Axis 1	Number of fingers
Y-Axis 2	Axis for empirical cumulative distribution function scaled from 0 to 1.
Facet	Finger Code
Trimming	The input data of the histograms SHALL be trimmed by the respective 95% percentile.
Data Source	<ul style="list-style-type: none"> distribution of XML-attribute <code>FingerAcquisition/FingerCapture/@duration</code> XML-attribute <code>FingerAcquisition/FingerCapture/@fc</code> for finger filtering XML node <code>FingerAcquisition/StartTime</code> for period filtering
Example Visualisation	Will be amended in a future version of this guideline.

Table 5.73. Histogram Finger Capture Duration per Finger

Attribute	Value
Name	Box Plot Finger capture duration comparison by finger
Purpose	This figure depicts box plots of the distributions of finger capture durations for multiple fingers. Thereby, e.g. fingers with unusual capture duration distribution characteristics SHALL be identified.
Type	Box plot (vertical)
X-Axis	Finger code
Y-Axis	Finger capture duration
Miscellaneous	The boxes SHALL be ordered by their finger code.
Trimming	The input data of the boxes SHALL be trimmed by the respective 95% percentile. The percentile SHALL be calculated for each box separately.
Data Source	<ul style="list-style-type: none"> distribution of XML-attribute <code>FingerAcquisition/FingerCapture/@duration</code> for Y-axis XML-attribute <code>FingerAcquisition/FingerCapture/@fc</code> for X-axis XML node <code>FingerAcquisition/StartTime</code> for period filtering
Example Visualisation	Will be amended in a future version of this guideline.

Table 5.74. Box Plot Finger Capture Duration Comparison

Attribute	Value
Name	Top and bottom table locations by finger acquisition duration
Purpose	Presenting locations with lowest and highest rank according to the finger acquisition duration
Row Labelling	The finger acquisition location.
Columns	<ul style="list-style-type: none"> Median of finger acquisition duration at the location. The duration can be calculated by subtracting <code>StartTime</code> from <code>EndTime</code>. Number of finger acquisitions at the location as goodness estimator
Miscellaneous	<ul style="list-style-type: none"> value column for ordering is the median of finger acquisition duration

Attribute	Value
	<ul style="list-style-type: none"> • ascending order (the lower, the better)
Data Source	<ul style="list-style-type: none"> • An XML-node with location or host information for location column. This data may also be located in sources external to this Technical Guideline. • XML nodes <code>FingerAcquisition/StartTime</code> and <code>FingerAcquisition/EndTime</code> for the median duration calculation • XML node <code>FingerAcquisition/StartTime</code> for period filtering

Table 5.75. Top and Bottom Locations by Finger Acquisition Duration

5.13.4.10. Finger Capture Duration

Attribute	Value
ID	FP-GENERIC-12
Name	Missing fingers
Purpose	This evaluation SHALL give insights in distribution of missing fingers.
Plots	<ul style="list-style-type: none"> • Stacked bar plot (Table 5.77) • Stacked bar plot (Table 5.78) • Histograms (Table 5.79, facet) • Stacked bar plots (Table 5.80)
Tables	<ul style="list-style-type: none"> • Lookup table for stacked bar plot (Table 5.77) • Lookup table for stacked bar plot (Table 5.78) • Lookup tables for histogram (Table 5.79) • Lookup tables for stacked bar plot (Table 5.80) • Top and bottom table (Table 5.81)

Table 5.76. Evaluation Finger Capture Duration

Attribute	Value
Name	Stacked bar plot relative frequencies of applicants with at least one missing finger
Purpose	This figure depicts a stacked bar plot of the relative frequencies of applicants with at least one missing finger. Thereby, e.g. globally unusually frequent numbers of applicants with missing fingers SHALL be detected.
Type	Stacked bar plot (horizontal)
X-Axis	Relative frequencies of applicants with at least on missing finger and no missing finger scaled from 0 to 1.
Data Source	<ul style="list-style-type: none"> • Number of processes with at least one and without any XML node <code>FingerAcquisition/FingerMissing</code> • XML node <code>FingerAcquisition/StartTime</code> for period filtering
Example Visualisation	Will be amended in a future version of this guideline.

Table 5.77. Stacked Bar Plot Relative Frequencies of Applicants with a Missing Finger

Attribute	Value
Name	Stacked bar plot reason for missing fingers

Attribute	Value
Purpose	This figure depicts a stacked bar plot of the relative frequencies of missing fingers by reason for finger missing. Thereby, e.g. the major reason for missing fingers SHALL be identified.
Type	Stacked bar plot (horizontal)
X-Axis	Relative frequencies of the number of missing fingers by reason for missing scaled from 0 to 1.
Data Source	<ul style="list-style-type: none"> counts of XML nodes <code>FingerAcquisition/FingerMissing</code> XML-attribute <code>FingerAcquisition/FingerMissing/@reason</code> for bar partitioning XML node <code>FingerAcquisition/StartTime</code> for period filtering
Example Visualisation	Will be amended in a future version of this guideline.

Table 5.78. Stacked Bar Plot Relative Frequencies Missing Finger Reason

Attribute	Value
Name	Histogram missing fingers
Purpose	This histogram depicts the distribution of missing fingers. Thereby, e.g. the detection of unexpected high numbers of missing fingers is of interest.
Type	Histogram with Cumulative Distribution Function
X-Axis	Number of missing fingers per applicant
Y-Axis 1	Number of applicants
Y-Axis 2	Axis for empirical cumulative distribution function scaled from 0 to 1.
Facet	Reason for missing finger
Data Source	<ul style="list-style-type: none"> distribution of the number of XML nodes <code>FingerAcquisition/FingerMissing</code> per applicant XML node <code>FingerAcquisition/StartTime</code> for period filtering XML-attribute <code>FingerAcquisition/FingerMissing/@reason</code> for facet
Example Visualisation	Will be amended in a future version of this guideline.

Table 5.79. Histogram Number of Missing Fingers

Attribute	Value
Name	Stacked bar plot missing finger relative frequencies by finger
Purpose	This figure depicts a stacked bar plot of the relative frequencies of missing fingers by finger. Thereby, e.g. fingers which are frequently missing SHALL be identified.
Type	Stacked bar plot (horizontal)
X-Axis	Finger Code
Y-Axis	Relative frequencies of the finger acquisitions with finger missing scaled from 0 to 1.
Facet	reason for missing finger
Data Source	<ul style="list-style-type: none"> counts of XML nodes <code>FingerAcquisition/FingerMissing</code> relative to counts of XML nodes <code>FingerAcquisition</code> XML-attribute <code>FingerAcquisition/FingerMissing/@fc</code> for bar partitioning

Attribute	Value
	<ul style="list-style-type: none"> XML node <code>FingerAcquisition/StartTime</code> for period filtering XML-attribute <code>FingerAcquisition/FingerMissing/@reason</code> for facet
Example Visualisation	Will be amended in a future version of this guideline.

Table 5.80. Stacked Bar Plot Relative Frequencies Missing Fingers

Attribute	Value
Name	Top and bottom table locations by relative frequencies of at least on missing finger per process
Purpose	Presenting locations with lowest and highest rank according to the relative frequencies of process with at least one missing finger.
Row Labelling	The finger acquisition location.
Columns	<ul style="list-style-type: none"> Relative frequencies of finger acquisition processes with at least on missing finger (Value) Number of finger acquisitions at the location as goodness estimator
Miscellaneous	<ul style="list-style-type: none"> ascending order (the lower, the better)
Data Source	<ul style="list-style-type: none"> Number of processes with and without existing XML nodes <code>FingerAcquisition/FingerMissing</code>. If no XML node exists this process SHALL count for processes without missing fingers XML node <code>FingerAcquisition/StartTime</code> for period filtering An XML-node with location or host information for location column. This data may also be located in sources external to this Technical Guideline.

Table 5.81. Top and Bottom Locations by Relative Frequencies of at least one Missing Finger per Process

5.13.4.11. Sequence Errors

Attribute	Value
ID	FP-GENERIC-13
Name	Sequence Errors
Purpose	This evaluation SHALL give insights in the distribution of sequence errors.
Plots	<ul style="list-style-type: none"> Histograms (Table 5.84) Stacked Bar Plot (Table 5.83)
Tables	<ul style="list-style-type: none"> Lookup table for histograms (Table 5.84) Lookup table for stacked bar plot (Table 5.83)

Table 5.82. Evaluation Sequence Errors

Attribute	Value
Name	Stacked bar plot for proportion of finger acquisition with sequence errors
Purpose	This stacked bar plot depicts the relative frequencies of finger acquisitions with and without sequence errors to recognize e.g. globally unusual high number of acquisitions with sequence errors.
Type	Stacked Bar Plot (horizontal)
X-Axis	Relative frequencies of finger acquisitions with and without sequence errors.

Attribute	Value
Data Source	<ul style="list-style-type: none"> Number of processes with and without existing XML node <code>FingerAcquisition/SequenceError</code> XML node <code>FingerAcquisition/StartTime</code> for period filtering
Example Visualisation	Will be amended in a future version of this guideline.

Table 5.83. Stacked Bar Finger Acquisitions With Sequence Errors

Attribute	Value
Name	Histogram number of sequence errors
Purpose	This histogram depicts the distribution of the number of sequence errors. Thereby, e.g. the detection of unexpected high numbers of sequence errors SHALL be possible.
Type	Histogram with Cumulative Distribution Function
X-Axis	Number of finger acquisitions
Y-Axis 1	Number of sequence errors
Y-Axis 2	Axis for empirical cumulative distribution function scaled from 0 to 1.
Data Source	<ul style="list-style-type: none"> XML node <code>FingerAcquisition/StartTime</code> for period filtering distribution of XML nodes <code>FingerAcquisition/SequenceError</code>
Example Visualisation	Will be amended in a future version of this guideline.

Table 5.84. Histogram Number of Sequence Errors

5.13.4.12. Segmentation Errors

Attribute	Value
ID	FP-GENERIC-14
Name	Segmentation Errors
Purpose	This evaluation SHALL give insights in the distribution of segmentation errors.
Plots	<ul style="list-style-type: none"> Stacked Bar Plot (Table 5.86)
Tables	Lookup table for stacked bar plot (Table 5.86)

Table 5.85. Evaluation Segmentation Errors

Attribute	Value
Name	Stacked bar plot for proportion of finger acquisition with segmentation errors
Purpose	This stacked bar plot depicts the relative frequencies of finger acquisitions with and without segmentation errors to recognize e.g. globally unusual high number of acquisitions with segmentation errors.
Type	Stacked Bar Plot (horizontal)
X-Axis	Relative frequencies of finger acquisitions with and without segmentation errors.
Data Source	<ul style="list-style-type: none"> Number processes with and without existing XML node <code>FingerAcquisition/SegmentationError</code>

Attribute	Value
	<ul style="list-style-type: none"> XML node <code>FingerAcquisition/StartTime</code> for period filtering
Example Visualisation	Will be amended in a future version of this guideline.

Table 5.86. Stacked Bar Finger Acquisitions With Segmentation Errors

5.13.4.13. Segmentation Errors

Attribute	Value
ID	FP-GENERIC-15
Name	Uniqueness Checks
Purpose	This evaluation SHALL give insights in the distribution of uniqueness checks.
Plots	<ul style="list-style-type: none"> Stacked Bar Plot (Table 5.88) Stacked Bar Plot (Table 5.89)
Tables	<ul style="list-style-type: none"> Lookup table for histograms (Table 5.88) Lookup table for stacked bar plot (Table 5.89) Top and bottom table (Table 5.90)

Table 5.87. Evaluation Uniqueness Checks

Attribute	Value
Name	Stacked bar plot for proportion of finger acquisition with uniqueness check errors
Purpose	This stacked bar plot depicts the relative frequencies of finger acquisitions with and without uniqueness errors to recognize e.g. globally unusual high number of acquisitions with uniqueness errors.
Type	Stacked Bar Plot (horizontal)
X-Axis	Relative frequencies of finger acquisitions with and without uniqueness errors.
Data Source	<ul style="list-style-type: none"> Number of processes with and without existing XML node <code>FingerAcquisition/UniquenessCheck</code>. If no XML node exists or if it exists and its XML-attribute result is false, this process SHALL count for processes without uniqueness check errors. XML node <code>FingerAcquisition/StartTime</code> for period filtering
Example Visualisation	Will be amended in a future version of this guideline.

Table 5.88. Stacked Bar Uniqueness Check Errors per Finger Acquisition

Attribute	Value
Name	Stacked bar plot of relative frequencies of finger duplicates
Purpose	This stacked bar plot depicts the relative frequencies of finger duplicates to recognize e.g. duplicates with unusual high number of occurrences.
Type	Stacked Bar Plot (horizontal)
X-Axis	Relative frequencies of duplicates
Data Source	<ul style="list-style-type: none"> Distribution of XML node <code>FingerAcquisition/UniquenessCheck/Duplicates/Duplicate</code>

Attribute	Value
	<ul style="list-style-type: none"> XML node <code>FingerAcquisition/StartTime</code> for period filtering
Example Visualisation	Will be amended in a future version of this guideline.

Table 5.89. Stacked Bar Finger Duplicates

Attribute	Value
Name	Top and bottom table locations by number of uniqueness check errors
Purpose	Presenting locations with lowest and highest rank according to the number of uniqueness
Row Labelling	The finger acquisition location.
Columns	<ul style="list-style-type: none"> Relative frequencies of finger acquisition processes with uniqueness check errors of the location (Value) Number of finger acquisitions at the location as goodness estimator
Miscellaneous	<ul style="list-style-type: none"> value column for ordering is the relative frequencies of finger acquisitions with uniqueness check error ascending order (the lower, the better)
Data Source	<ul style="list-style-type: none"> Number of processes with and without existing XML node <code>FingerAcquisition/UniquenessCheck</code>. If no XML node exists or if it exists and its XML-attribute result is false, this process SHALL count for processes without uniqueness check errors. XML node <code>FingerAcquisition/StartTime</code> for period filtering

Table 5.90. Top and Bottom Locations by Number of Uniqueness Check Errors

5.13.5. FM EVA-FP-CENTRAL

This functional module defines requirements for the evaluation of fingerprint images in central systems different from acquisition clients based on the XML-element “fp-gid-eval”.

5.13.5.1. Requirements

The evaluations defined by this module SHALL be provided if the application specific EVA-FP module requires them. For each quality algorithm deployed at the central side, the evaluations defined by this module SHALL be made provided.

5.13.5.2. NFIQ 2.0 Fingerprint Image Quality

Attribute	Value
ID	FP-CENTRAL-1
Name	NFIQ 2.0 fingerprint image quality
Purpose	This evaluation SHALL give insights in the NFIQ 2.0 fingerprint image quality. Thereby, e.g. the detection of fingers with quality below defined thresholds is of interest.
Plots	<ul style="list-style-type: none"> Stacked bar plot (Table 5.92) Histogram (Table 5.93) per finger Box plot (Table 5.94)
Tables	<ul style="list-style-type: none"> Lookup table for histogram (Table 5.93) per finger Lookup table for box plot (Table 5.94) Threshold Configuration Table

Attribute	Value
	<ul style="list-style-type: none"> • <code>FingerQualityAssurance/FingerQuality/Software</code> for component information • <code>FingerQualityAssurance/FingerQuality/fp</code> for threshold information.

Table 5.91. Evaluation NFIQ 2.0 Fingerprint Image Quality

Attribute	Value
Name	Stacked bar plot finger quality errors
Purpose	This figure depicts a stacked bar plot of the relative frequencies of finger quality assessments with and without errors. Thereby, e.g. the detection of high numbers of fingers which no quality was measured for is of interest.
Type	Stacked bar plot (horizontal)
X-Axis	Relative frequencies of the finger quality assessments without error and with error (by error code).
Miscellaneous	Note, that the bar segment of fingers with error code SHALL be further segmented by the error code values itself. If the rejection reason is "other", the error code SHALL be used as value in addition e.g. "other, Error Code 5".
Data Source	<ul style="list-style-type: none"> • counts of XML nodes <code>FingerQualityAssurance/FingerQuality/</code> with and without <code>FingerQualityAssurance/FingerQuality/ErrorCodes</code> • XML-nodes <code>FingerQualityAssurance/FingerQuality/ErrorCode</code> • XML node <code>StartTime</code> for period filtering
Example Visualisation	Will be amended in a future version of this guideline.

Table 5.92. Stacked Bar Plot Relative Finger Quality Assessment Errors

Attribute	Value
Name	Histogram NFIQ 2.0 fingerprint image quality per finger
Purpose	This histogram depicts the distribution of NFIQ 2.0 fingerprint image quality for a single finger. Thereby, e.g. the share of fingers below the finger's threshold is of interest.
Type	Histogram with Cumulative Distribution Function
X-Axis	NFIQ 2.0 score scaled from 0 to 100
Y-Axis 1	Number of fingers
Y-Axis 2	Axis for empirical cumulative distribution function scaled from 0 to 1.
Facet	Finger Code
Miscellaneous	<ul style="list-style-type: none"> • The histogram SHALL only depict the quality distribution for a single finger. No histogram without facet grouping. • A vertical line SHALL indicate the threshold for the finger. The line SHALL be annotated with the numeric threshold and the relative number of fingers below the threshold.
Data Source	<ul style="list-style-type: none"> • distribution of XML attribute <code>FingerQualityAssurance/FingerQuality/fp/@result</code> • XML-attribute <code>FingerQualityAssurance/FingerQuality/fp/@fc</code> for finger filtering • XML-attribute <code>FingerQualityAssurance/FingerQuality/fp/@threshold</code> for threshold of finger

Attribute	Value
	<ul style="list-style-type: none"> XML node <code>StartTime</code> for period filtering
Example Visualisation	Will be amended in a future version of this guideline.

Table 5.93. Histogram NFIQ 2.0 Fingerprint Image Quality

Attribute	Value
Name	Box plot NFIQ 2.0 fingerprint image quality comparison by finger
Purpose	This figure depicts box plots of the distributions of NFIQ 2.0 fingerprint image quality for multiple fingers. Thereby, e.g. the fingers with unusual distribution characteristics SHALL be identified.
Type	Box plot
X-Axis	Finger code
Y-Axis	NFIQ 2.0 score
Data Source	<ul style="list-style-type: none"> distribution of XML-attribute <code>FingerQualityAssurance/FingerQuality/fp/@result</code> for Y-axis XML-attribute <code>FingerQualityAssurance/FingerQuality/fp/@fc</code> for X-axis XML node <code>StartTime</code> for period filtering
Example Visualisation	Will be amended in a future version of this guideline.

Table 5.94. Box Plot NFIQ 2.0 Fingerprint Image Quality Finger Comparison

5.13.6. FM EVA-FP-PAD

This functional module defines requirements for the evaluation of presentation attack detection at fingerprint acquisitions.

5.13.6.1. Requirements

The evaluations defined by this module shall be provided if the application specific EVA-FP module requires them.

5.13.6.2. Finger Presentation Attack Detection

Attribute	Value
ID	FP-PAD-1
Name	Presentation attack detection
Purpose	This evaluation shall give insights in the distribution of presentation attack detection results.
Plots	<ul style="list-style-type: none"> Histograms (Table 5.99) Stacked bar plot (Table 5.96)
Tables	<ul style="list-style-type: none"> Lookup table for histograms (Table 5.96) Top and bottom tables (Table 5.97, Table 5.98)

Table 5.95. Evaluation Finger Presentation Attack Detection

Attribute	Value
Name	Stacked bar plot activation of presentation attack detection
Purpose	This stacked bar plot depicts the relative frequencies of finger acquisition processes with and without activated presentation attack detection e.g. to detect misconfigured hosts.
Type	Stacked Bar Plot (horizontal)
X-Axis	Relative frequencies of finger acquisition processes with and without presentation detection enabled.
Data Source	<ul style="list-style-type: none"> Number of processes with and without existing <code>FingerAcquisition/PADInformation</code> XML node <code>FingerAcquisition/StartTime</code> for period filtering
Example Visualisation	Will be amended in a future version of this guideline.

Table 5.96. Stacked Bar Finger Acquisitions with Presentation Attack Detection

Attribute	Value
Name	Top and bottom table locations with low and high presentation attack detection activation quote.
Purpose	Presenting locations with high and low activation of presentation attack detection functionality.
Row Labelling	The finger acquisition location.
Columns	<ul style="list-style-type: none"> Relative frequency of finger acquisition processes with a <code>FingerAcquisition/PADInformation</code> Number of finger acquisitions as goodness estimator
Miscellaneous	<ul style="list-style-type: none"> value column for ordering is relative frequency of finger acquisition processes with a <code>FingerAcquisition/PADInformation</code> ascending order (the lower, the better)
Data Source	<ul style="list-style-type: none"> count of XML-node <code>FingerAcquisition/PADInformation/ProbePADInfo/</code> count of XML-node <code>FingerAcquisition</code> An XML-node with location or host information. This data may also be located in sources external to this Technical Guideline. XML node <code>FingerAcquisition/StartTime</code> for period filtering

Table 5.97. Top and Bottom Locations by Activation of Presentation Attack Detection

Attribute	Value
Name	Top and bottom table locations with low and high detected presentation attacks.
Purpose	Presenting locations with high and low relative numbers of detections of presentation attacks.
Row Labelling	The finger acquisition location.
Columns	<ul style="list-style-type: none"> Share of presentation attack detection probes with “detected” presentation attack detection. Number of presentation attack detection probes as goodness estimator
Miscellaneous	<ul style="list-style-type: none"> value column for ordering is the share of “detected” results ascending order (the lower, the better)

Attribute	Value
Data Source	<ul style="list-style-type: none"> • XML-attribute <code>FingerAcquisition/PADInformation/ProbePADInfo/@total</code> for share of PAD probes with “detected” result • An XML-node with location or host information. This data may also be located in sources external to this Technical Guideline. • XML node <code>FingerAcquisition/StartTime</code> for period filtering

Table 5.98. Top and Bottom Locations by Detected Presentation Attack Detection

Attribute	Value
Name	Histogram presentation attack detection scores
Purpose	This histogram depicts the distribution of presentation attack detection scores. Thereby, e.g. the detection of unexpected high numbers of low presentation attack detection results shall be possible.
Type	Histogram with Cumulative Distribution Function
X-Axis	Presentation attack detection score
Y-Axis 1	Number of probes
Y-Axis 2	Axis for empirical cumulative distribution function scaled from 0 to 1.
Facet	<ul style="list-style-type: none"> • Finger Code • PAD Subsystem Hardware • Finger Acquisition Software
Data Source	<ul style="list-style-type: none"> • XML node <code>FingerAcquisition/StartTime</code> for period filtering • distribution of XML-attribute <code>FingerAcquisition/PADInformation/ProbePADInfo/pad/@result</code> • XML-attribute <code>FingerAcquisition/FingerCapture/@fc</code> for facet • XML node <code>FingerAcquisition/PADInformation/PADSubsystem</code> for facet, child node values concatenated • XML node <code>FingerAcquisition/Hardware</code> for facet, child node values concatenated
Example Visualisation	Will be amended in a future version of this guideline.

Table 5.99. Histogram Number of Presentation Attack Detection Scores

5.13.7. FM EVA-FP-AAD

This functional module defines fingerprint evaluations for the arrival attestation document application profile.

5.13.7.1. Requirements

The evaluations specified by this module SHALL be provided. In addition all evaluation defined by Table 5.100 SHALL be provided.

ID	Remark
FP-CENTRAL-*	
FP-GENERIC-1	
FP-GENERIC-2	For rolled and flat acquisition separately.

ID	Remark
FP-GENERIC-3	For rolled and flat acquisition separately.
FP-GENERIC-4	For rolled and flat acquisition separately.
FP-GENERIC-5	For rolled and flat acquisition separately.
FP-GENERIC-6	For rolled and flat acquisition separately.
FP-GENERIC-7	For rolled and flat acquisition separately.
FP-GENERIC-8	For rolled and flat acquisition separately.
FP-GENERIC-9	For rolled and flat acquisition separately.
FP-GENERIC-10	
FP-GENERIC-11	
FP-GENERIC-12	
FP-GENERIC-13	
FP-GENERIC-14	
FP-GENERIC-15	

Table 5.100. Required Evaluations EVA-FP-AAD

5.13.8. FM EVA-FI-GENERIC

This functional module defines requirements for the evaluation of facial image acquisitions.

5.13.8.1. Requirements

The evaluations defined by this module SHALL be provided if the application specific EVA-FI module requires them.

5.13.8.2. Facial Image Capture Components

Attribute	Value
ID	FI-GENERIC-1
Name	Software version of facial image capture
Purpose	This evaluation SHALL give insights in the used software for capturing facial images during the report period.
Plots	<ul style="list-style-type: none"> Heat Map facial image acquisition software usage (Table 2) Heat Map facial image hardware usage (Table 3)
Tables	<ul style="list-style-type: none"> Lookup table for heat maps (Table 5.102 and Table 5.103) Component Usage Tables for <ul style="list-style-type: none"> software of facial image acquisition <code>FaceAcquisition/Software</code> hardware of facial image acquisition <code>FaceAcquisition/Hardware</code>

Table 5.101. Evaluation Facial Image Capture Component

Attribute	Value
Name	Heat map of the number of facial image acquisitions by software version

Attribute	Value
Purpose	This heat map depicts the distributions of the number of facial image acquisitions by software version over a given period to recognize e.g. new software versions and their introduction phase.
Type	Heat Map
Row Labelling	The facial image acquisition software version
Column Labelling	Time, calendar week if yearly report, day if monthly report
Cells	The frequency of facial image acquisitions with the given software version
Data Source	<ul style="list-style-type: none"> The number of XML nodes <code>FaceAcquisition</code> for the cell counts The XML nodes <code>FaceAcquisition/Software</code> for the row dimension XML node <code>FaceAcquisition/StartTime</code> for period filtering and the column dimension
Colours	Maximum: "column wise" (case 1)
Example Visualisation	Will be amended in a future version of this guideline.

Table 5.102. Heat Map Facial Image Acquisitions by Software

Attribute	Value
Name	Heat map of the number of facial image acquisitions by hardware version
Purpose	This heat map depicts the distributions of the number of facial image acquisitions by hardware version over a given period to recognize e.g. detect new hardware versions and their introduction phase.
Type	Heat Map
Row Labelling	The facial image acquisition hardware version
Column Labelling	Time, calendar week if yearly report, day if monthly report
Cells	The count of facial image acquisitions with the relevant hardware version
Data Source	<ul style="list-style-type: none"> The number of XML nodes <code>FaceAcquisition</code> for the cell counts The XML nodes <code>FaceAcquisition/Hardware</code> for the row dimension XML node <code>FaceAcquisition/StartTime</code> for period filtering and the column dimension
Colours	Maximum: "column wise" (case 1)
Example Visualisation	Will be amended in a future version of this guideline.

Table 5.103. Heat Map Facial Image Acquisitions by Hardware

5.13.8.3. Facial Image Acceptability

Attribute	Value
ID	FI-GENERIC-2
Name	Facial image acceptability

Attribute	Value
Purpose	This evaluation SHALL give insights in the acceptability of facial images. Thereby it can be measured if the percentage of acceptable images is reasonable.
Plots	<ul style="list-style-type: none"> Stacked Bar Plot (Table 5.105) Stacked Bar Plot (Table 5.106)
Tables	<ul style="list-style-type: none"> Lookup table for stacked bar plot (Table 5.105) Lookup table for stacked bar plot (Table 5.106) Top and bottom table (Table 5.107) Threshold Configuration Table <ul style="list-style-type: none"> FaceAcquisition/FaceQuality/Software for component information FaceAcquisition/FaceQuality/qa for threshold information.

Table 5.104. Evaluation Facial Image Acceptability

Attribute	Value
Name	Stacked bar plot of the total acceptability of facial images in the reporting period
Purpose	This stacked bar plot SHALL give insights in the total acceptability of the facial images. Thereby, it SHALL e.g. be measured if the total quality of the images is reasonable.
Type	Stacked Bar Plot (horizontal)
X-Axis	Relative percentage of acceptable and unacceptable facial images.
Miscellaneous	<ul style="list-style-type: none"> An image is acceptable if it fulfils all mandatory quality criteria defined by the function module Section 5.4.2. If any mandatory quality criteria is not fulfilled, the facial image's total acceptability SHALL be nominated as unacceptable.
Data Source	<ul style="list-style-type: none"> XML-attributes FaceAcquisition/FaceQuality/qa/@result, FaceAcquisition/FaceQuality/qa/@tmin, FaceAcquisition/FaceQuality/qa/@tmax for the X-axis calculation XML node FaceAcquisition/StartTime for period filtering
Example Visualisation	Will be amended in a future version of this guideline.

Table 5.105. Stacked Bar Plot Total Facial Image Quality

Attribute	Value
Name	Stacked bar plot acceptability of facial images by quality criteria.
Purpose	This plot SHALL give insights in the distribution of results for different facial image quality criteria. This information can give insight in which aspects have to be addressed for future technology improvements.
Y-Axis	Relative frequencies of results of quality criteria.
X-Axis	The facial image quality criteria (QA-FI-SB)
Data Sources	<ul style="list-style-type: none"> XML-attribute FaceAcquisition/FaceQuality/qa/@result, FaceAcquisition/FaceQuality/qa/@tmin, FaceAcquisition/FaceQuality/qa/@tmax for the Y-axis XML-attribute FaceAcquisition/FaceQuality/qa/@id for the X-axis

Attribute	Value
	<ul style="list-style-type: none"> XML node <code>FaceAcquisition/StartTime</code> for period filtering
Example Visualisation	Will be amended in a future version of this guideline.

Table 5.106. Stacked Bar Plot Acceptability of Facial Images by Quality Metrics

Attribute	Value
Name	Top and bottom table locations by total acceptability of facial images
Purpose	Presenting locations with lowest and highest rank according to total facial image quality
Row Labelling	The facial image acquisition location.
Columns	<ul style="list-style-type: none"> Relative frequencies of results of facial image total acceptability Number of facial image acquisitions at the location as goodness estimator
Miscellaneous	<ul style="list-style-type: none"> ascending order (the lower, the better) An image is acceptable if it fulfils all mandatory quality criteria defined by Section 5.4.2. If any mandatory quality criteria is not fulfilled, the image's total acceptability is unacceptable.
Data Source	<ul style="list-style-type: none"> XML-attributes <code>FaceAcquisition/FaceQuality/qa/@result</code>, <code>FaceAcquisition/FaceQuality/qa/@tmin</code>, <code>FaceAcquisition/FaceQuality/qa/@tmax</code> XML-attribute <code>FaceAcquisition/FaceQuality/qa/@id</code> to determine whether criteria is mandatory XML node <code>FaceAcquisition/StartTime</code> for period filtering An XML-node with location or host information for location column. This data may also be located in sources external to this Technical Guideline.

Table 5.107. Top and Bottom Locations by Total Acceptability of Facial Images

5.13.9. FM EVA-FI-CENTRAL

This functional module defines requirements for the evaluation of facial image acquisitions on central systems different from acquisition clients based on the XML-element "ph-gid-eval".

5.13.9.1. Requirements

The evaluations defined by this module SHALL be provided if the application specific EVA-FI module requires them. For each quality algorithm deployed at the central side, the evaluations defined by this module SHALL be made provided.

5.13.9.2. Facial Image Central Acceptability

Attribute	Value
ID	FI-CENTRAL-1
Name	Facial image acceptability
Purpose	This evaluation SHALL give insights in the acceptability of facial images. Thereby it can be measured if the percentage of acceptable images is reasonable.
Plots	<ul style="list-style-type: none"> Stacked Bar Plot (Table 5.109) Stacked Bar Plot (Table 5.110)

Attribute	Value
Tables	<ul style="list-style-type: none"> • Lookup table for stacked bar plot (Table 5.109) • Lookup table for stacked bar plot (Table 5.110) • Threshold Configuration Table <ul style="list-style-type: none"> • <code>FaceQualityAssurance/FaceQuality/Software</code> for component information • <code>FaceQualityAssurance/FaceQuality/qa</code> for threshold information.

Table 5.108. Evaluation Facial Image Central Acceptability

Attribute	Value
Name	Stacked bar plot of the total acceptability of facial images in the reporting period
Purpose	This stacked bar plot SHALL give insights in the total acceptability of the facial images. Thereby, it SHALL e.g. be measured if the total quality of the images is reasonable.
Type	Stacked Bar Plot (horizontal)
X-Axis	Relative percentage of acceptable and unacceptable facial images.
Miscellaneous	<ul style="list-style-type: none"> • An image is acceptable if it fulfils all mandatory quality criteria defined by the function module QA-FI-SB. • If any mandatory quality criteria is not fulfilled, the facial image's total acceptability SHALL be nominated as unacceptable.
Data Source	<ul style="list-style-type: none"> • XML-attributes <code>FaceQualityAssurance/FaceQuality/qa/@result</code>, <code>FaceQualityAssurance/FaceQuality/qa/@tmin</code>, <code>FaceQualityAssurance/FaceQuality/qa/@tmax</code> for the X-axis calculation • XML node <code>StartTime</code> for period filtering
Example Visualisation	Will be amended in a future version of this guideline.

Table 5.109. Stacked Bar Plot Total Central Facial Image Quality

Attribute	Value
Name	Stacked bar plot acceptability of facial images by quality criteria.
Purpose	This plot SHALL give insights in the distribution of results for different facial image quality criteria. This information can give insight in which aspects have to be addressed for future technology improvements.
Y-Axis	Relative frequencies of results of quality criteria.
X-Axis	The facial image quality criteria (QA-FI-SB)
Data Sources	<ul style="list-style-type: none"> • XML-attribute <code>FaceQualityAssurance/FaceQuality/qa/@result</code>, <code>FaceQualityAssurance/FaceQuality/qa/@tmin</code>, <code>FaceQualityAssurance/FaceQuality/qa/@tmax</code> for the Y-axis • XML-attribute <code>FaceAcquisition/FaceQuality/qa/@id</code> for the X-axis • XML node <code>StartTime</code> for period filtering
Example Visualisation	Will be amended in a future version of this guideline.

Table 5.110. Stacked Bar Plot Central Acceptability of Facial Images by Quality Metrics

5.13.10. FM EVA-FI-AAD

This functional module defines facial image evaluations for the arrival attestation document application profile.

5.13.10.1. Requirements

The evaluations specified by this module SHALL be provided. In addition all evaluation defined by Table 5.111 SHALL be provided.

ID	Remark
FI-CENTRAL-*	
FI-GENERIC-*	

Table 5.111. Required Evaluations EVA-FI-AAD

List of Abbreviations

Abbreviation	Description
ABIS	Automated Biometric Identification System
AFIS	Automated Fingerprint Identification System
AH	Acquisition Hardware
AS	Acquisition Software
BEA	Biometric Evaluation Authority
BIP	Biometric Image Processing
BPCER	bona fide presentation classification error rate
BPNRR	bona fide presentation non-response rate
CDF	Cumulative Distribution Function
CIR	Central Identity Register
CMP	Biometric Comparison
COD	Coding
COM	Compression
CTF	contrast transfer function
FM	Function Module
FMR	false-match-rate
FNMR	false-non-match-rate
GSAT	German Standard for AFIS Transactions
GUI	graphical user interface
LOG	Logging
O	Operation
PAD	presentation attack detection
PAP	Partial Application Process
QA	Quality Assessment
REF	Reference Storage
SNR	signal-to-noise ratio
UI	User Interface
WSQ	Wavelet Scalar Quantisation

Bibliography

[AKNV] *Ankunftsnachweisverordnung.*

[AsylG] *Asylgesetz of 02. September 2008 (BGBl. I S. 1798), last changed by law from 20. July 2017 (BGBl. I S. 2780).*

[AZRG] *Allgemeine Verwaltungsvorschrift zum Gesetz über das Ausländerzentralregister und zur Verordnung zur Durchführung des Gesetzes über das Ausländerzentralregister of 26. October 2009.*

[AZRGDV] *Verordnung zur Durchführung des Gesetzes über das Ausländerzentralregister of 17. May 1995 (BGBl. I S. 695), last changed by Art. 3 VO zur Umsetzung aufenthaltsrechtlicher Richtlinien der EU zur Arbeitsmigration of 1. August 2017 (BGBl. I S. 3066).*

[EBTS/F] *FBI Electronic Biometric Transmission Specification Version 8, Appendix F, September 2007.*

[GSAT3] *German Standard for AFIS transactions. XML schema files version 3.02.*

[ISO_10918-1] *ISO/IEC 10918-1:1994: "Information technology – Digital compression and coding of continuous-tone still images: Requirements and guidelines".*

[ISO_FACE] *ISO/IEC 19794-5:2005 "Information technology - Biometric data interchange formats – Part 5: Face image data".*

[ISO_FACE_2011] *ISO/IEC 19794-5:2011 "Information technology - Biometric data interchange formats – Part 5: Face image data".*

[ISO_FINGER] *ISO/IEC 19794-4:2005 "Information technology - Biometric data interchange formats – Part 4: Finger image data".*

[ISO_PAD_1] *ISO/IEC 30107-1: Information technology – Biometric presentation attack detection – Part 1: Framework.*

[ISO_PAD_3] *ISO/IEC 30107-3: Information technology – Biometric presentation attack detection – Part 3: Testing and reporting.*

[NFIQ2.0] *http://www.nist.gov/itl/iad/ig/development_nfiq_2.cfm, Source code from Apr 28, 2016.*

[RFC4122] *RFC 4122: A Universally Unique Identifier (UUID) URN Namespace.*

[UN REGIO] *Standard Country or Area Codes for statistical Use, United Nations Department Of Economic and Social Affairs Statistics Division, 1999.*